

# JVC

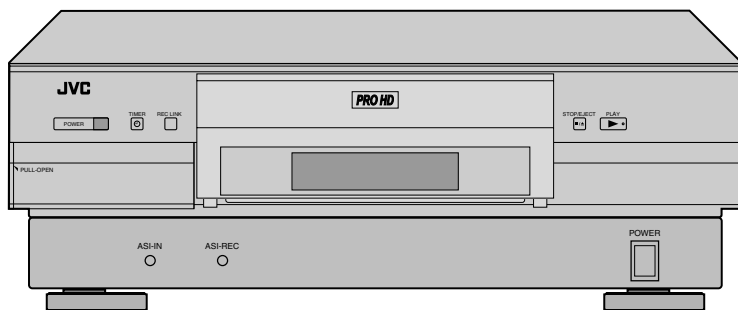

## DIGITAL VIDEO RECORDER

# SR-VDA300U



**PRO HD**  
*Hi-Fi*



**Super VHS ET**



## ***INSTRUCTIONS***

**For Customer Use:**

Enter below the Model No. and Serial No. which are located on the rear of cabinet. Retain this information for future reference.

Model No. \_\_\_\_\_

Serial No. \_\_\_\_\_

**Dear Customer,**

Thank you for purchasing the JVC digital video recorder. Before use, please read the safety information and precautions contained in the following pages to ensure safe use of your new VCR.

**CAUTIONS**

**CAUTION**  
RISK OF ELECTRIC SHOCK  
DO NOT OPEN



**CAUTION:** TO REDUCE THE RISK OF ELECTRIC SHOCK.  
DO NOT REMOVE COVER (OR BACK).  
NO USER-SERVICEABLE PARTS INSIDE.  
REFER SERVICING TO QUALIFIED SERVICE PERSONNEL.



The lightning flash with arrowhead symbol, within an equilateral triangle, is intended to alert the user to the presence of uninsulated "dangerous voltage" within the product's enclosure that may be of sufficient magnitude to constitute a risk of electric shock to persons.



The exclamation point within an equilateral triangle is intended to alert the user to the presence of important operating and maintenance (servicing) instructions in the literature accompanying the appliance.

**WARNING:**  
**TO PREVENT FIRE OR SHOCK HAZARD, DO NOT EXPOSE THIS UNIT TO RAIN OR MOISTURE.**

**CAUTION:**

This video cassette recorder should be used with AC 120V~, 60Hz only.  
To prevent electric shocks and fire hazards, DO NOT use any other power source.

**CAUTION:**

TO PREVENT ELECTRIC SHOCK, MATCH WIDE BLADE OF PLUG TO WIDE SLOT, FULLY INSERT.

**ATTENTION:**

POUR ÉVITER LES CHOCS ÉLECTRIQUES, INTRODUIRE LA LAME LA PLUS LARGE DE LA FICHE DANS LA BORNE CORRESPONDANTE DE LA PRISE ET POUSSER JUSQU'AU FOND.

**Note to CATV system installer:**

This reminder is provided to call the CATV system installer's attention to Article 820-40 of the NEC that provides guidelines for proper grounding and, in particular, specifies that the cable ground shall be connected to the grounding system of the building, as close to the point of cable entry as practical.

**NOTE:**

Change or modifications not approved by the party responsible for compliance could void the user's authority to operate the equipment.  
This equipment has been tested and found to comply with the limits for a Class B digital device, pursuant to Part 15 of the FCC Rules. These limits are designed to provide reasonable protection against harmful interference in a residential installation. This equipment generates, uses, and can radiate radio frequency energy and, if not installed and used in accordance with the instructions, may cause harmful interference to radio communications. However, there is no guarantee that interference will not occur in a particular installation. If this equipment does cause harmful interference to radio or television reception, which can be determined by turning the equipment off and on, the user is encouraged to try to correct the interference by one or more of the following measures:

- Reorient or relocate the receiving antenna.
- Increase the separation between the equipment and receiver.
- Connect the equipment into an outlet on a circuit different from that to which the receiver is connected.
- Consult the dealer or an experienced radio/TV technician for help.

When the equipment is installed in a cabinet or a shelf, make sure that it has sufficient space on all sides to allow for ventilation (10 cm or more on both sides, on top and at the rear.)

When discarding batteries, environmental problems must be considered and the local rules or laws governing the disposal of these batteries must be followed strictly.

VCR Plus+, C<sup>3</sup> and PlusCode are registered trademarks of Gemstar Development Corporation.  
The VCR Plus+ system is manufactured under license from Gemstar Development Corporation.



- Cassettes marked "D-VHS", "S-VHS" and "VHS" can be used with this video cassette recorder. However, PRO HD recordings are possible only with cassettes marked "D-VHS". By using S-VHS ET it is possible to record and play back with S-VHS picture quality on VHS cassettes with this VCR.
- PRO HD is a new digital memory system that uses D-VHS tapes. PRO HD was developed as a memory system for multimedia applications that require storage for large volumes of information, such as for digital video.
- Manufactured under license from Dolby Laboratories. "Dolby", "Pro Logic", and the double-D symbol are trademarks of Dolby Laboratories. Confidential unpublished works. Copyright 1992-1997 Dolby Laboratories. All rights reserved.

# IMPORTANT PRODUCT SAFETY INSTRUCTIONS

Electrical energy can perform many useful functions. But improper use can result in potential electrical shock or fire hazards. This product has been engineered and manufactured to assure your personal safety. In order not to defeat the built-in safeguards, observe the following basic rules for its installation, use and servicing.

## ATTENTION:

Follow and obey all warnings and instructions marked on your product and its operating instructions. For your safety, please read all the safety and operating instructions before you operate this product and keep this booklet for future reference.

## INSTALLATION

### 1. Grounding or Polarization

(A) Your product may be equipped with a polarized alternating-current line plug (a plug having one blade wider than the other). This plug will fit into the power outlet only one way. This is a safety feature.

If you are unable to insert the plug fully into the outlet, try reversing the plug. If the plug should still fail to fit, contact your electrician to replace your obsolete outlet. Do not defeat the safety purpose of the polarized plug.

(B) Your product may be equipped with a 3-wire grounding-type plug, a plug having a third (grounding) pin. This plug will only fit into a grounding-type power outlet. This is a safety feature.

If you are unable to insert the plug into the outlet, contact your electrician to replace your obsolete outlet. Do not defeat the safety purpose of the grounding-type plug.

### 2. Power Sources

Operate your product only from the type of power source indicated on the marking label. If you are not sure of the type of power supply to your home, consult your product dealer or local power company. If your product is intended to operate from battery power, or other sources, refer to the operating instructions.

### 3. Overloading

Do not overload wall outlets, extension cords, or integral convenience receptacles as this can result in a risk of fire or electric shock.

### 4. Power Cord Protection

Power supply cords should be routed so that they are not likely to be walked on or pinched by items placed upon or against them, paying particular attention to cords at plugs, convenience receptacles, and the point where they exit from the product.

### 5. Ventilation

Slots and openings in the cabinet are provided for ventilation. To ensure reliable operation of the product and to protect it from overheating, these openings must not be blocked or covered.

- Do not block the openings by placing the product on a bed, sofa, rug or other similar surface.
- Do not place the product in a built-in installation such as a bookcase or rack unless proper ventilation is provided or the manufacturer's instructions have been adhered to.

### 6. Wall or Ceiling Mounting

The product should be mounted to a wall or ceiling only as recommended by the manufacturer.

## ANTENNA INSTALLATION INSTRUCTIONS

### 1. Outdoor Antenna Grounding

If an outside antenna or cable system is connected to the product, be sure the antenna or cable system is grounded so as to provide some protection against voltage surges and built-up static charges. Article 810 of the National Electrical Code, ANSI/NFPA 70, provides information with regard to proper grounding of the mast and supporting structure, grounding of the lead-in wire to an antenna discharge unit, size of grounding connectors, location of antenna discharge unit, connection to grounding electrodes, and requirements for the grounding electrode.

### 2. Lightning

For added protection for this product during a lightning storm, or when it is left unattended and unused for long periods of time, unplug it from the wall outlet and disconnect the antenna or cable system. This will prevent damage to the product due to lightning and power-line surges.

### 3. Power Lines

An outside antenna system should not be located in the vicinity of overhead power lines or other electric light or power circuits, or where it can fall into such power lines or circuits. When installing an outside antenna system, extreme care should be taken to keep from touching such power lines or circuits as contact with them might be fatal.

**EXAMPLE OF ANTENNA GROUNDING AS PER NATIONAL ELECTRICAL CODE, ANSI/NFPA 70**

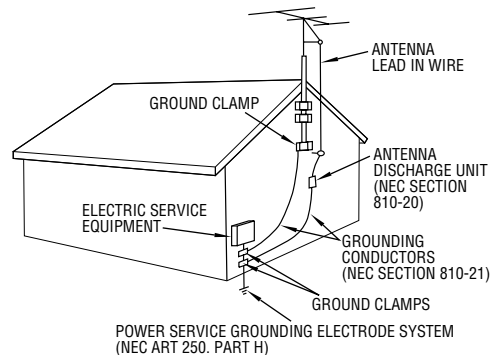

NEC – NATIONAL ELECTRICAL CODE

## USE

### 1. Accessories

To avoid personal injury:

- Do not place this product on an unstable cart, stand, tripod, bracket, or table. It may fall, causing serious injury to a child or adult, and serious damage to the product.
- Use only with a cart, stand, tripod, bracket, or table recommended by the manufacturer or sold with the product.
- Use a mounting accessory recommended by the manufacturer and follow the manufacturer's instructions for any mounting of the product.
- Do not try to roll a cart with small casters across thresholds or deep-pile carpets.

### 2. Product and Cart Combination

A product and cart combination should be moved with care. Quick stops, excessive force, and uneven surfaces may cause the product and cart combination to overturn.

PORTABLE CART WARNING  
(Symbol provided by RETAC)



### 3. Water and Moisture

Do not use this product near water—for example, near a bath tub, wash bowl, kitchen sink or laundry tub, in a wet basement, or near a swimming pool and the like.

### 4. Object and Liquid Entry

Never push objects of any kind into this product through openings as they may touch dangerous voltage points or short-out parts that could result in a fire or electric shock. Never spill liquid of any kind on the product.

### 5. Attachments

Do not use attachments not recommended by the manufacturer of this product as they may cause hazards.

### 6. Cleaning

Unplug this product from the wall outlet before cleaning. Do not use liquid cleaners or aerosol cleaners. Use a damp cloth for cleaning.

### 7. Heat

The product should be situated away from heat sources such as radiators, heat registers, stoves, or other products (including amplifiers) that produce heat.

## SERVICING

### 1. Servicing

If your product is not operating correctly or exhibits a marked change in performance and you are unable to restore normal operation by following the detailed procedure in its operating instructions, do not attempt to service it yourself as opening or removing covers may expose you to dangerous voltage or other hazards. Refer all servicing to qualified service personnel.

### 2. Damage Requiring Service

Unplug this product from the wall outlet and refer servicing to qualified service personnel under the following conditions:

- a. When the power supply cord or plug is damaged.
- b. If liquid has been spilled, or objects have fallen into the product.
- c. If the product has been exposed to rain or water.
- d. If the product does not operate normally by following the operating instructions. Adjust only those controls that are covered by the operating instructions as an improper adjustment of other controls may result in damage and will often require extensive work by a qualified technician to restore the product to its normal operation.
- e. If the product has been dropped or damaged in any way.
- f. When the product exhibits a distinct change in performance—this indicates a need for service.

### 3. Replacement Parts

When replacement parts are required, be sure the service technician has used replacement parts specified by the manufacturer or which have the same characteristics as the original part. Unauthorized substitutions may result in fire, electric shock or other hazards.

### 4. Safety Check

Upon completion of any service or repairs to this product, ask the service technician to perform safety checks to determine that the product is in safe operating condition.

## HOW TO USE THIS INSTRUCTION MANUAL

- The Index on pages 69 – 74 lists frequently-used terms, and the number of the page on which they are used or explained in the manual. This section also illustrates the controls and connections on the front and rear panel, the front display panel and the Remote.
- The  mark signals a reference to another page for instructions or related information.
- Operation buttons necessary for the various procedures are clearly indicated through the use of illustrations at the beginning of each major section.

## BEFORE YOU INSTALL YOUR NEW VCR . . .

. . . please read the sections/literature listed below.

- “CAUTIONS” on page 2.
- “IMPORTANT PRODUCT SAFETY INSTRUCTIONS” on the previous page.

Failure to heed the following precautions may result in damage to the recorder, remote control or video cassette.

1. **DO NOT place the recorder...**
  - ... in an environment prone to extreme temperatures or humidity.
  - ... in direct sunlight.
  - ... in a dusty environment.
  - ... in an environment where strong magnetic fields are generated.
  - ... on a surface that is unstable or subject to vibration.
2. **DO NOT block the recorder's ventilation openings or holes.**  
(If the ventilation openings or holes are blocked by a newspaper or cloth, etc., the heat may not be able to get out.)
3. **DO NOT place heavy objects on the recorder or remote control.**
4. **DO NOT place anything which might spill on top of the recorder or remote control.**  
(If water or liquid is allowed to enter this equipment, fire or electric shock may be caused.)
5. **DO NOT expose the apparatus to dripping or splashing.**
6. **DO NOT use this equipment in a bathroom or places with water. Also DO NOT** place any containers filled with water or liquids (such as cosmetics or medicines, flower vases, potted plants, cups, etc.) on top of this unit.
7. **DO NOT place any naked flame sources, such as lighted candles, on the apparatus.**
8. **AVOID violent shocks to the recorder during transport.**

## ABOUT HEAD CLEANING

After an extended period of use, the video heads can become dirty, resulting in a loss of picture or sound during playback. If this happens, clean the video heads by using the optional cleaning tapes.

### Symptoms of dirty video heads:

- The picture is not clear, or does not appear. There is no sound.
- Mosaic (block) noise appears in the picture.
- Black or mosaic horizontal stripes appear in the picture.
- The picture stops (as if the tape is paused).
- A blank black or blue screen appears.
- The picture is fuzzy. (VHS playback)

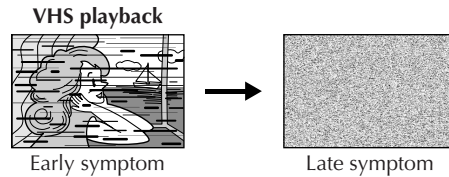

Use a cleaning tape designed specifically for D-VHS video heads (JVC D-VHS video head cleaner DFC-2) to clean the video heads.

- Follow the instructions that are provided with the cleaning tape.

### If you still do not get a clear picture after using a cleaning tape:

- The heads may be worn. Contact your nearest JVC dealer.
- During VHS playback, if there is a tracking problem, the picture may appear fuzzy. Adjust the tracking manually (⏪ pg. 23).

<b>INSTALLING YOUR NEW VCR</b>	<b>7</b>	<b>TIMER RECORDING</b>	<b>34</b>
<b>Connections</b> .....	<b>7</b>	<b>VCR Plus+® Timer Programing</b> .....	<b>34</b>
<b>INITIAL SETTINGS</b>	<b>9</b>	<b>Changing VCR Plus+ Setting</b> .....	<b>36</b>
<b>Plug &amp; Play Setting</b> .....	<b>9</b>	<b>Express Timer Programing</b> .....	<b>38</b>
Auto Clock Set/Auto Tuner Set .....	9	Checking program settings .....	40
<b>Clock Setting</b> .....	<b>10</b>	Canceling or changing program settings .....	40
Preparations .....	10	<b>PRO HD SYSTEM</b>	<b>42</b>
Setting clock semiautomatically		<b>Features</b> .....	<b>42</b>
— Semiauto Clock Set .....	11	<b>Connection and Preparation</b> .....	<b>43</b>
Setting clock manually — Manual Clock Set .....	12	Connection .....	43
<b>Tuner Setting</b> .....	<b>13</b>	Preparations .....	44
Setting channels automatically		<b>Recording</b> .....	<b>45</b>
— Auto Channel Set .....	13	<b>Password Set Up</b> .....	<b>46</b>
Setting channels manually		<b>Playback</b> .....	<b>47</b>
— Manual Channel Set .....	14	<b>OTHER USEFUL FUNCTIONS</b>	<b>48</b>
<b>Cable Box Control Setting</b> .....	<b>15</b>	<b>Useful Function Settings</b> .....	<b>48</b>
Installing Controller .....	15	<b>Satellite Auto Recording</b> .....	<b>54</b>
Setting cable box output channel & brand .....	16	<b>JLIP ID Number Setting</b> .....	<b>55</b>
<b>DBS Receiver Control Setting</b> .....	<b>18</b>	<b>EDITING</b>	<b>56</b>
Installing Controller .....	18	<b>Edit From Camcorder</b> .....	<b>56</b>
Setting DBS receiver output channel & brand .....	19	<b>Edit To Or From Another VCR/</b>	
<b>BASIC PLAYBACK AND RECORDING</b>	<b>21</b>	<b>Other Devices</b> .....	<b>58</b>
<b>Basic Playback</b> .....	<b>21</b>	<b>MULTI-BRAND REMOTE CONTROL</b>	<b>60</b>
<b>Basic Playback Features</b> .....	<b>22</b>	<b>TV Brand Setting</b> .....	<b>60</b>
Changing display information .....	22	<b>Cable Box Brand Setting</b> .....	<b>61</b>
Checking tape position .....	22	<b>DBS Receiver Brand Setting</b> .....	<b>62</b>
Playing back tape repeatedly — Repeat Playback .....	23	<b>Changing Remote Control Code</b> .....	<b>63</b>
Adjusting tracking condition		<b>TROUBLESHOOTING</b>	<b>64</b>
— Tracking Adjustments .....	23	Error Codes and Messages .....	67
Selecting monitor sound — Audio Monitor .....	23	Questions and answers .....	68
Automatic operations after rewinding		<b>INDEX</b>	<b>69</b>
— Next Function Memory .....	24	List of terms .....	69
Locating beginning of recordings — Index Search .....	24	Front panel .....	70
Locating beginning of timer recordings		Rear panel .....	71
— Instant Review .....	25	Front display panel .....	72
Skipping unwanted portions — Skip Search .....	25	Child Lock .....	72
Adjusting picture condition — Digital 3-DNR .....	25	On-screen display .....	73
<b>Basic Recording</b> .....	<b>26</b>	Remote .....	74
S-VHS/VHS Recording .....	27	<b>SPECIFICATIONS</b>	<b>75</b>
<b>Basic Recording Features</b> .....	<b>28</b>	<b>FOR SERVICING (Only in U.S.A.)</b>	<b>76</b>
Changing display information .....	28	<b>WARRANTY (Only in U.S.A.)</b>	<b>77</b>
Specifying recording length			
— Instant Timer Recording (ITR) .....	28		
Watching one program while recording another .....	29		
Showing on-screen display .....	29		
Recording on VHS tapes with S-VHS quality			
— Super VHS ET .....	29		
<b>SPECIAL EFFECT PLAYBACK</b>	<b>31</b>		
<b>Special Effect Playback</b> .....	<b>31</b>		
Locating particular scene rapidly			
— Picture Search .....	31		
■ High-Speed Picture Search .....	31		
■ Variable-Speed Picture Search .....	31		
Viewing still picture — Still Picture Playback .....	32		
Viewing still picture frame by frame			
— Frame-by-Frame Playback .....	32		
Viewing slow motion picture			
— Slow Motion Playback .....	33		

# Connections

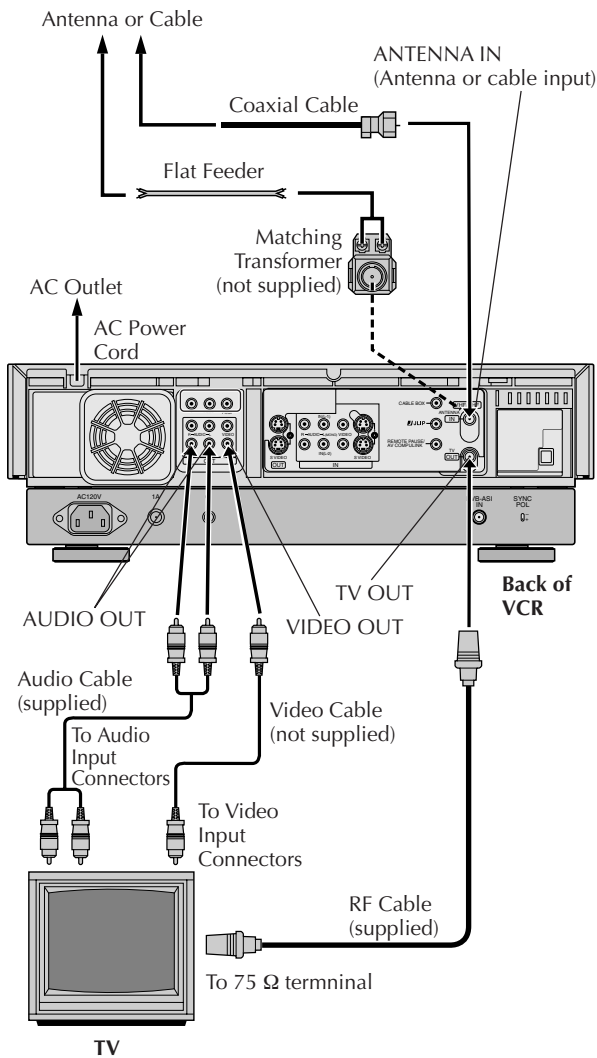

## Basic Connection

**1 Check contents**  
 Make sure the package contains all of the accessories listed in "SPECIFICATIONS" (☞ pg. 75).

**2 Situate VCR**  
 Place the VCR on a stable, horizontal surface.

**3 Connect VCR to TV**  
 The following connections are required.

- Disconnect the TV antenna from the TV.
- Connect the TV antenna cable to the ANTENNA IN terminal on the rear of the VCR.
- Connect the supplied RF cable between the TV OUT terminal on the rear of the VCR and the TV's antenna input terminal.
- Connect an audio/video cable between the AUDIO/VIDEO OUT connectors on the rear of the VCR and the audio/video input connectors on the TV.

### S-VIDEO Connection

- If you have a TV with S-VIDEO input terminals, see "S-VIDEO Connection" on page 8.

### Component Video Connection

- If you have a TV with component video input terminals, see "Component Video Connection" on page 8.

**Connect VCR to power source**  
 Connect the AC power plug to the AC outlet.

- The clock and tuner channels will automatically be set when the antenna is connected and when the AC power cord is first connected to an AC power outlet (☞ pg. 9). (If "Auto" or "CH" is displayed on the front display panel before the VCR is turned on, the clock and tuner channels are being set automatically. Wait until the clock time is displayed on the front display panel before turning on the VCR.)

**5 Final preparation for use**  
 Turn on the VCR.

- You can now perform basic playback (☞ pg. 21) or basic recording (☞ pg. 26).

## NOTES:

- Your TV must have audio/video input connector for the connection to the recorder.
- Even if you are using audio/video cables to connect your VCR to your TV, you must also connect it using the RF cable. This will ensure that you can record one show while watching another (☞ pg. 29).
- For full identification of the VCR's rear panel, refer to the Index (☞ pg. 73).
- When you play back the picture of 1080i, 720p, 480p image format, the signal is not output from the S-VIDEO or VIDEO output connector.



## S-VIDEO Connection

### CONNECT VCR TO TV

- Connect both the RF cable and the AV cables to the TV as explained in step 3 of "Basic Connection" (pg. 7).
- Connect the S-Video cable between the S VIDEO OUT terminal on the rear of the VCR and the S-VIDEO input connector on the TV.

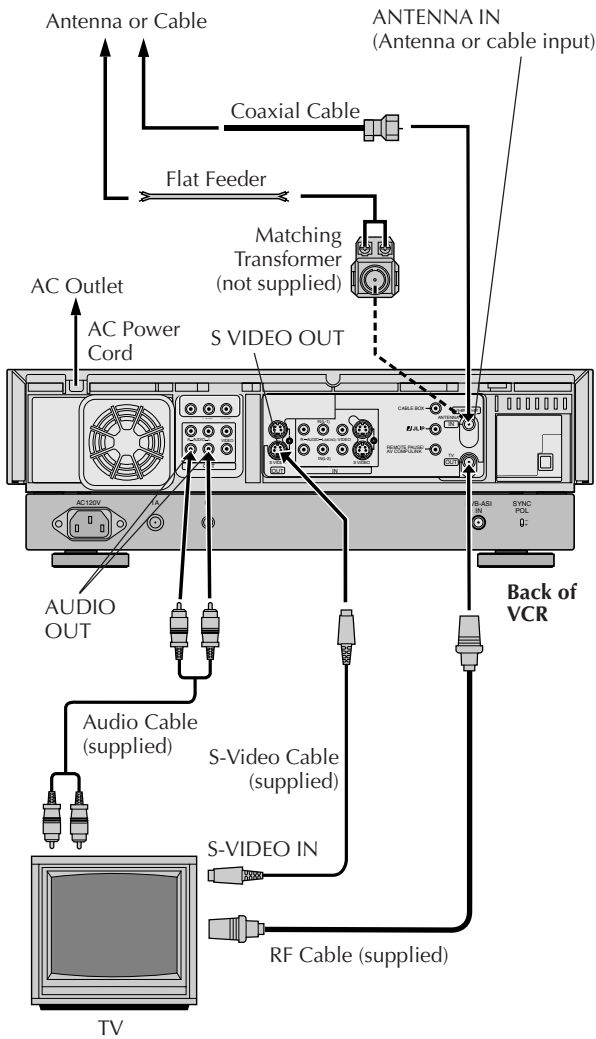

## Component Video Connection

### CONNECT VCR TO TV

- Connect both the RF cable and the AV cables to the TV as explained in step 3 of "Basic Connection" (pg. 7).
- Connect the component video cable between the Component video output terminals on the rear of the VCR and the component video input terminals on the TV.

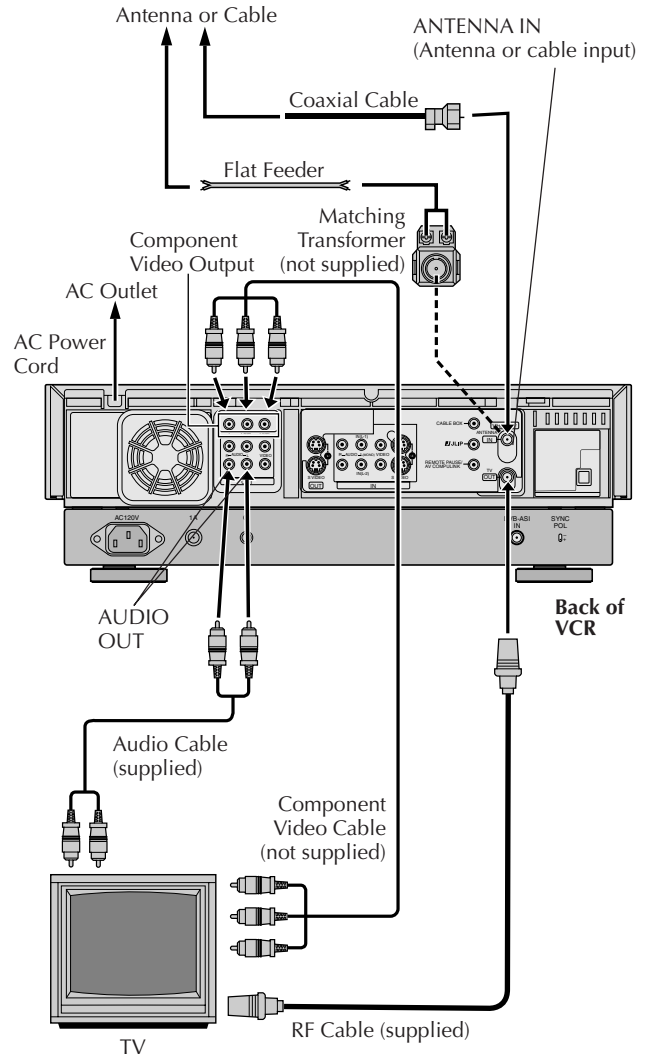

### NOTES:

- To make the most of the Super VHS picture performance we recommend that you use the supplied S-VIDEO cable to connect your VCR to a TV with an S-VIDEO input connector.
- To operate the VCR with your TV using the S-VIDEO connection, set your TV to the AV mode using the TV's remote control.  
You can also use the TV/VCR button on the VCR's remote control to set your TV to the AV mode. (pg. 60)
- When you play back the picture of 1080i, 720p, 480p image format, the signal is not output from the S-VIDEO or VIDEO output connector.

### NOTES:

- To change the settings or set the timer program on the menu screen, switch the TV's input mode for the connection with Audio cable.
- To view the picture of 480i image format on the TV, or to select and view ground wave broadcast, connect the component video cable to the TV's Y/Cb/Cr connectors. If your TV has only the Y/Pb/Pr connectors, connect also the S-VIDEO or VIDEO connectors between the VCR and TV.



# Plug & Play Setting

## Auto Clock Set/Auto Tuner Set

### ATTENTION

- If you use a cable box, Plug & Play will not function; set the clock and tuner channels separately. (☞ pg.10 – 14)
- It takes several minutes for the VCR to complete the Plug & Play setting.
- Do not press any buttons on the front panel or on the Remote while Plug & Play is in progress.

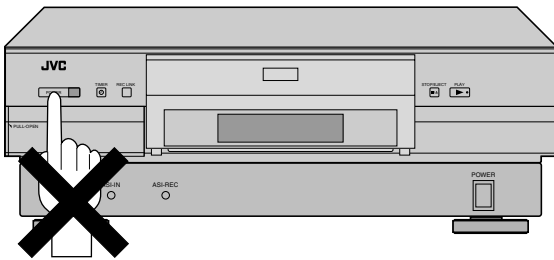

This VCR sets the clock and tuner channels automatically when AC power cord is first connected to an AC outlet. The antenna cable must be connected for the Plug & Play setting.

The time and date can be set automatically by the clock setting data transmitted from one of the regular TV broadcast channels. We call this TV channel the “host channel” and it is a PBS channel in your area.

### Perform Plug & Play setup

**Connect the antenna cable to the VCR (☞ pg. 7). Then connect the AC power cord to an AC outlet. Do not turn on the VCR.**

The clock and tuner channels will be set automatically.

### NOTES:

- *Auto Clock Set is performed first. “Auto” blinks on the front display panel during Auto Clock Set.*
- *Auto Channel Set is performed next. Auto Channel Set scans all the channels that are receivable by your VCR. During Auto Channel Set, the channel numbers are displayed as they are scanned and set.*
- *When Plug & Play setting has been complete successfully, the correct clock time is displayed. If you perform Plug & Play setting successfully, there is no need to perform the clock (☞ pg. 10) and tuner (☞ pg. 13) settings. If, however, you want to add or delete channels, and use the ghost reduction function, refer to Manual Channel Set on page 14.*

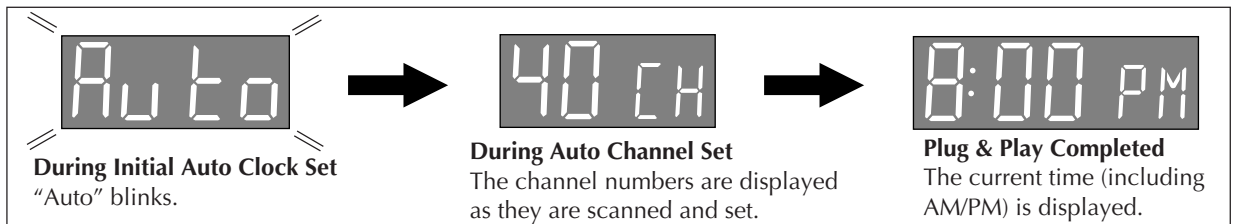

\* If an incorrect clock time or “-:-:-” appears on the display panel, see “What to do if Plug & Play setting failed” below.

### INFORMATION

- If “AUTO CLOCK” is set to “ON” on the Clock Set screen on page 11, the clock will be adjusted automatically by the host channel every hour (except 11:00 PM, midnight, 1:00 AM and 2:00 AM) using the incoming PBS channel clock setting data. (This automatic clock adjustment can only be performed when the VCR is turned off. The clock will be adjusted just on these hours — on the time displayed on the front display panel, not on the actual real time.) The default setting of “AUTO CLOCK” is “ON”.
- If the memory backup fails, because a power outage occurs or because the AC power cord is unplugged, Plug & Play will be performed when power is restored to the VCR.
- Poor antenna or cable signal may prevent the VCR from receiving the Auto clock setting data from the PBS channel. If this function is taking a considerable amount of time, it may be necessary to perform the Semiauto or Manual Clock Set procedure.

### What to do if Plug & Play setting failed

- If an incorrect time is displayed on the front display panel, you may be receiving the clock setting data of a PBS channel from an adjacent time zone, or an incorrect PBS channel from a cable TV system. In this case, perform the Semiauto (☞ pg. 11) or Manual Clock Set (☞ pg. 12) procedure.
- If “-:-:-” appears on the front display panel, your antenna cable may not be connected to the VCR or there may not be a Host PBS signal available in your area. Ensure that the antenna cable is connected correctly. Then turn on and off the VCR; the Plug & Play setting will be automatically reactivated. If Plug & Play setting is not performed though the antenna cable is connected correctly, perform Manual Clock Set (☞ pg. 12) and Auto Channel Set or Manual Channel Set (☞ pg. 13 or 14).

# Clock Setting

Turn on the VCR and the TV, and select the AV mode on the TV.

Perform clock setting only if the clock has not been set correctly by the Plug & Play setting or if you use a cable box.

Access the Clock Set screen to perform the Semiauto or Manual Clock Set. Each procedure starts from step ■ after preparation steps below are finished.

If you use a cable box, set the clock manually. (☞ pg. 12)

## Preparations

### ■ Access Main Menu screen

Press **MENU**.

### 2 Access Initial Set Up screen

Press  $\Delta$ / $\nabla$  to move the highlight bar (arrow) to "INITIAL SET UP", then press **OK**.

MAIN MENU

Passwrd SET UP  
FUNCTION SET UP  
TUNER SET UP  
▶ INITIAL SET UP

PRESS ( $\Delta$ / $\nabla$ ), THEN (OK)  
PRESS (MENU) TO END

### 3 Access Clock Set Up screen

Press  $\Delta$ / $\nabla$  to move the highlight bar (arrow) to "CLOCK SET UP", then press **OK**.

● "CABLE BOX USERS  
SET CLOCK  
MANUALLY"

appears on the screen for about 5 seconds, then the Clock Set screen appears.

INITIAL SET UP

▶ CLOCK SET UP  
JLIP ID SET UP

PRESS ( $\Delta$ / $\nabla$ ), THEN (OK)  
PRESS (MENU) TO END

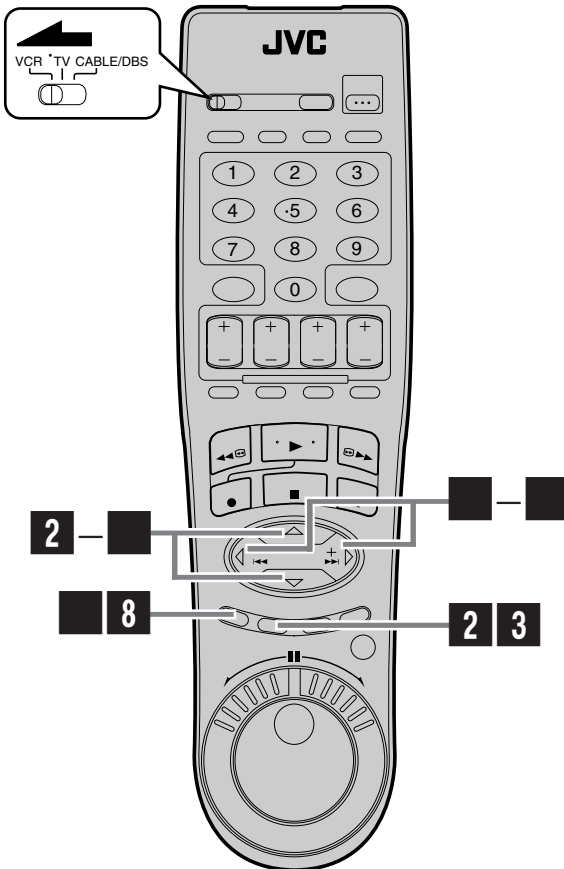

## Setting clock semiautomatically

### — Semiauto Clock Set

You can change the host channel/D.S.T./time zone setting manually.  
First follow steps **1** to **3** on page 10, then go to the following steps.

#### Set Auto Clock to ON

Press  $\Delta\nabla$  to move the highlight bar to "AUTO CLOCK", then press  $\triangleleft\rangle$  so that "ON" is selected.

##### CLOCK SET UP

```

TIME      DATE  YEAR
1:00PM   12/24 2003 WED
AUTO CLOCK: ON
HOST CH   : AUTO (CATV)
D.S.T.    : AUTO
TIME ZONE : AUTO
PRESS ( $\Delta\nabla$ ), THEN ( $\triangleleft\rangle$ )
PRESS (MENU) TO END
  
```

Then;

To select the host channel — go to step **5**.

To select the D.S.T. mode — go to step **6**.

To select the time zone — go to step **7**.

#### NOTE:

*The time set previously will be erased when "AUTO CLOCK", "HOST CH", "D.S.T." or "TIME ZONE" setting is changed.*

#### 5 Select host channel

You can either select "AUTO" or enter a PBS channel number.

Press  $\Delta\nabla$  to move the highlight bar to "HOST CH", then press  $\triangleleft\rangle$  until "AUTO" or the desired PBS channel number is selected.

#### NOTE:

*Some PBS channels do not transmit clock setting data.*

#### \* Auto Daylight Saving Time

*This function enables automatic adjustment of the VCR's clock at the start and end of Daylight Saving Time.*

*With Auto DST activated, . . .*

*. . . on the first Sunday of April at 2:00 AM, the clock is adjusted to 3:00 AM.*

*. . . on the last Sunday of October at 2:00 AM, the clock is adjusted to 1:00 AM.*

#### 6 Select D.S.T. mode

You have three choices:

**AUTO**— Select if you want to adjust your VCR's clock automatically by the incoming signal from the host channel. (Auto Daylight Saving Time\*)

**ON**— Adjustment will be made by the built-in clock itself.

**OFF**— Select when Daylight Saving Time does not apply to you.

Press  $\Delta\nabla$  to move the highlight bar to "D.S.T.", then press  $\triangleleft\rangle$  repeatedly until the desired setting is selected.

#### Select time zone

You can select the time zone automatically or manually.

Press  $\Delta\nabla$  to move the highlight bar to "TIME ZONE", press  $\triangleleft\rangle$  repeatedly until "AUTO" or the desired time zone is selected.

Each time you press the button, the time zone changes as follows:

$\rightleftharpoons$  AUTO  $\rightleftharpoons$  ATLANTIC  $\rightleftharpoons$  EASTERN

$\rightleftharpoons$  CENTRAL  $\rightleftharpoons$  MOUNTAIN  $\rightleftharpoons$  PACIFIC

$\rightleftharpoons$  ALASKA  $\rightleftharpoons$  HAWAII  $\rightleftharpoons$  (back to the beginning)

#### NOTE:

*If an incorrect clock time is displayed by the Plug & Play setting, you may be receiving the clock setting data of a PBS channel from an adjacent time zone or from an incorrect PBS channel from a cable TV system. If you selected "AUTO" for the host channel in step **5**, be sure to select the correct time zone manually.*

#### 8 Return to normal screen

Press MENU.

#### IMPORTANT

*Turn off the VCR after performing Semiauto Clock Set. "Auto" will appear on the front display panel while the clock is being set. The current clock time will appear automatically when the clock setting is complete.*

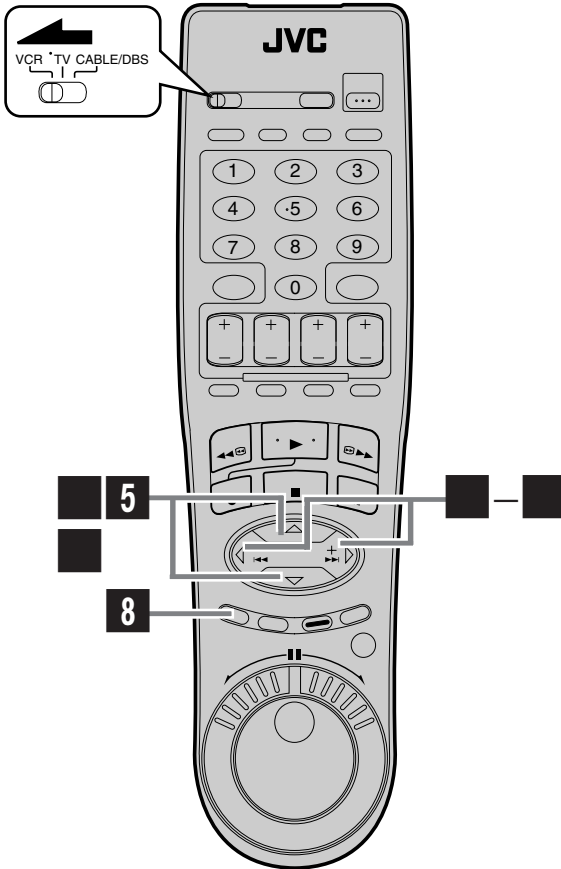

## Setting clock manually

### — Manual Clock Set

First follow steps **1** to **3** on page 10, then go to the following steps.

#### Set time

Press  $\triangleleft \triangleright$  until the desired time appears, then press  $\nabla$ .

- Holding  $\triangleleft \triangleright$  changes the time in 30-minute intervals.
- When the time is entered manually, "AUTO CLOCK" is automatically set to "OFF", and "HOST CH" and "TIME ZONE" disappear.

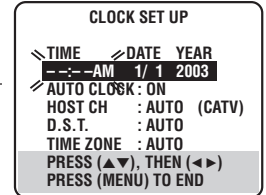

#### 5 Set date

Press  $\triangleleft \triangleright$  until the desired date appears, then press  $\nabla$ .

- Holding  $\triangleleft \triangleright$  changes the date in 15-day intervals.

#### 6 Set year

Press  $\triangleleft \triangleright$  until the desired year appears.

#### Select D.S.T. mode

Press  $\triangle \nabla$  to move the highlight bar to "D.S.T.", then press  $\triangleleft \triangleright$  to select "ON" or "OFF".

- ON**— Adjustment will be made by the built-in clock itself.
- OFF**— Select when Daylight Saving Time does not apply to you.

#### 8 Start clock

Press **MENU** and normal screen appears.

### To make corrections any time during the process

Press  $\triangle \nabla$  repeatedly until the item you want to change blinks, then press  $\triangleleft \triangleright$ .

# Tuner Setting

Turn on the VCR and the TV, and select the AV mode on the TV.

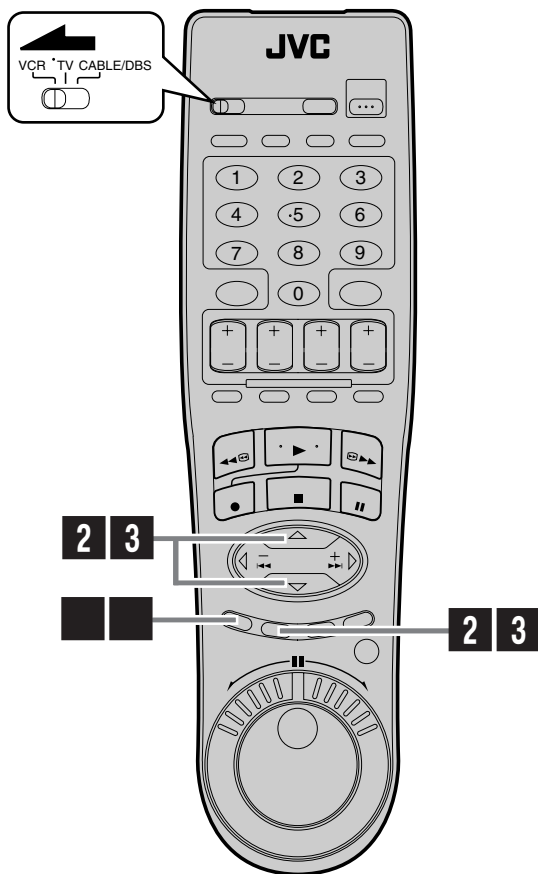

## Setting channels automatically

### — Auto Channel Set

Use Auto Channel Set only if channels have not been set correctly by the Plug & Play setting. If you want to add or delete channels, and want to use the ghost reduction function, use Manual Channel Set (☞ pg. 14).

### Access Main Menu screen

Press **MENU**.

### 2 Access Tuner Set Up screen

Press  $\Delta\nabla$  to move the highlight bar (arrow) to "TUNER SET UP", then press **OK**.

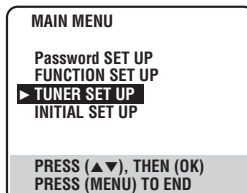

### 3 Perform Auto Channel Set

You can automatically set the receivable channels in your area in the order of their frequencies.

Press  $\Delta\nabla$  to move the highlight bar (arrow) to "AUTO CHANNEL SET UP", then press **OK**.

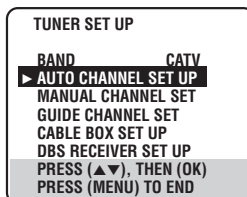

### NOTES:

- When Auto Channel Set is complete, "SCAN COMPLETED" appears on screen.
- If the scan was unsuccessful, "SCAN COMPLETED-NO SIGNAL" appears on screen. Check the connections and start again.

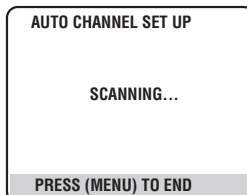

### Return to normal screen

Press **MENU**.

### INFORMATION

The VCR selects the correct band (TV or CATV) automatically during Auto Channel Set. The selected band will be displayed on the right side of "BAND" on the Tuner Set Up screen.

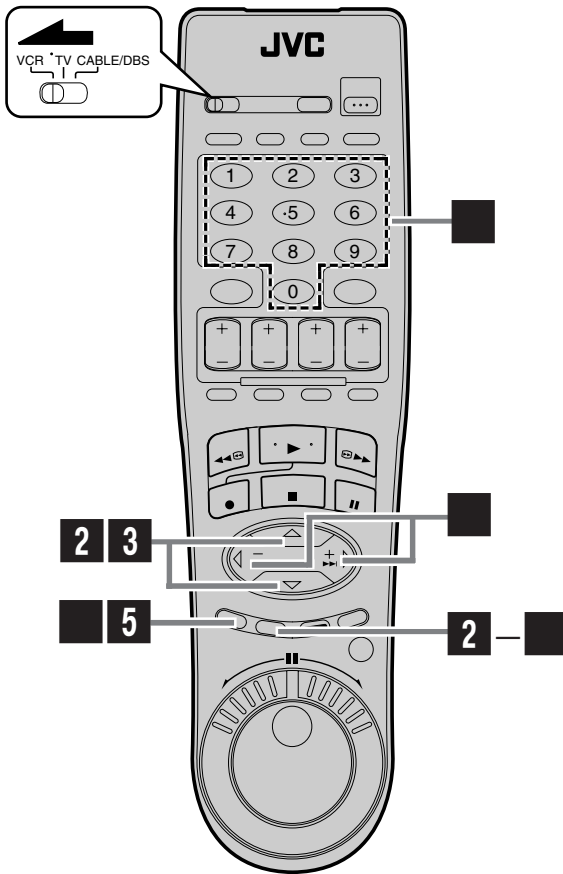

### 3 Access Manual Channel Set screen

Press  $\Delta \nabla$  to move the highlight bar (arrow) to "MANUAL CHANNEL SET", then press **OK**.

#### TUNER SET UP

BAND CATV  
 AUTO CHANNEL SET UP  
 ► **MANUAL CHANNEL SET**  
 GUIDE CHANNEL SET  
 CABLE BOX SET UP  
 DBS RECEIVER SET UP  
 PRESS ( $\Delta \nabla$ ), THEN (OK)  
 PRESS (MENU) TO END

### Add or skip desired channels

#### To add channels

- Press the **Number** keys or  $\leftarrow \rightarrow$  to input a channel number you want to add.
- ② Press **OK** to set to "ADD".
- ③ Repeat ● and ② to add other channels.

#### MANUAL CHANNEL SET UP

(CATV)  
**CH 45 ADD**

PRESS NUMBER KEY (0-9)  
 OR ( $\leftarrow \rightarrow$ ), THEN (OK)  
 PRESS (MENU) TO END

#### To skip channels

- Press the **Number** keys or  $\leftarrow \rightarrow$  to input a channel number you want to skip.
- ② Press **OK** to set to "SKIP".
- ③ Repeat ● and ② to skip other channels.

#### MANUAL CHANNEL SET UP

(CATV)  
**CH 46 SKIP**

PRESS NUMBER KEY (0-9)  
 OR ( $\leftarrow \rightarrow$ ), THEN (OK)  
 PRESS (MENU) TO END

### 5 Return to normal screen

Press **MENU**.

## Setting channels manually

### — Manual Channel Set

You can add the channels you want or delete the channels you do not want manually.

You can also select the ghost reduction mode for each channel while adding the channels you want.

#### Access Main Menu screen

Press **MENU**.

#### 2 Access Tuner Set Up screen

Press  $\Delta \nabla$  to move the highlight bar (arrow) to "TUNER SET UP", then press **OK**.

# Cable Box Control Setting

## Suggested location

Place the cable box on top of the VCR. Attach the VCR's Controller to the top of the VCR with the Controller's transmitter pointed towards the cable box's remote sensor.

## ATTENTION:

The Controller can also control a DBS receiver. If both a cable box and a DBS receiver are used, position the Controller so its signal reaches the remote sensors on both the cable box and DBS receiver.

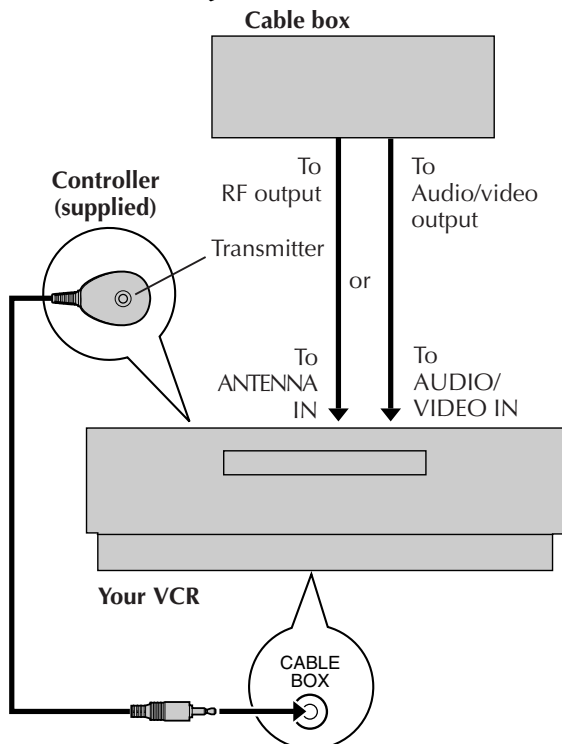
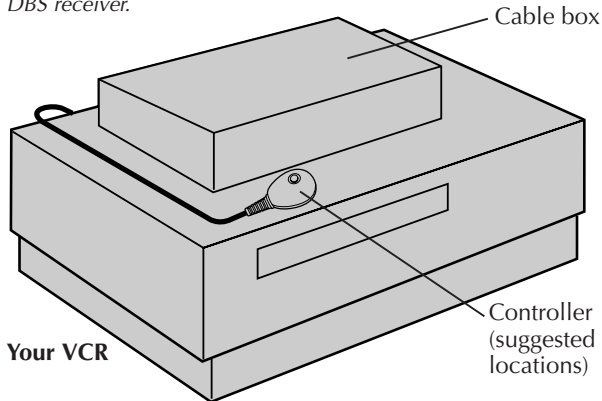

The following procedure is required if you receive your TV channels through a cable box (descrambler). The Controller allows the VCR to automatically switch the cable box channel during timer recording. The Controller is effective for recording broadcasts that have been programmed using VCR Plus+ (☞ pg. 34) or Express timer programming (☞ pg. 38).

## Installing Controller

### 1 Situate Controller

Place the Controller so that its transmitter is facing the cable box's remote sensor.

- Make sure the path between the Controller and the cable box's remote sensor is not blocked.

### 2 Attach Controller

Fix securely using the adhesive strip attached on the back of the Controller.

### 3 Connect cable box to VCR

- **If your cable box does not have audio/video output connectors**  
Connect the RF output terminal on the cable box to the ANTENNA IN terminal on the rear of your VCR.
- **If your cable box has audio/video output connectors**  
Connect an audio/video cable between the AUDIO/VIDEO IN connectors on the rear of the VCR and the audio/video output connectors on the cable box.

## NOTE:

When connecting your cable box, refer to its instruction manual.

### Connect Controller to VCR

Connect the Controller to the CABLE BOX Controller connector on the rear panel.

### How to control the cable box

This VCR has two separate methods to control your cable box.

- The VCR's wireless Remote can control your cable box. This eliminates the need for a separate cable box's Remote.
- The VCR's Controller can also control your cable box. This allows the VCR to change your cable box's channel number during timer recording.

Each method must be set up separately. To set up the VCR's Remote, refer to page 67. To set up the Controller, go to page 16.



Turn on the VCR and the TV, and select the AV mode on the TV.

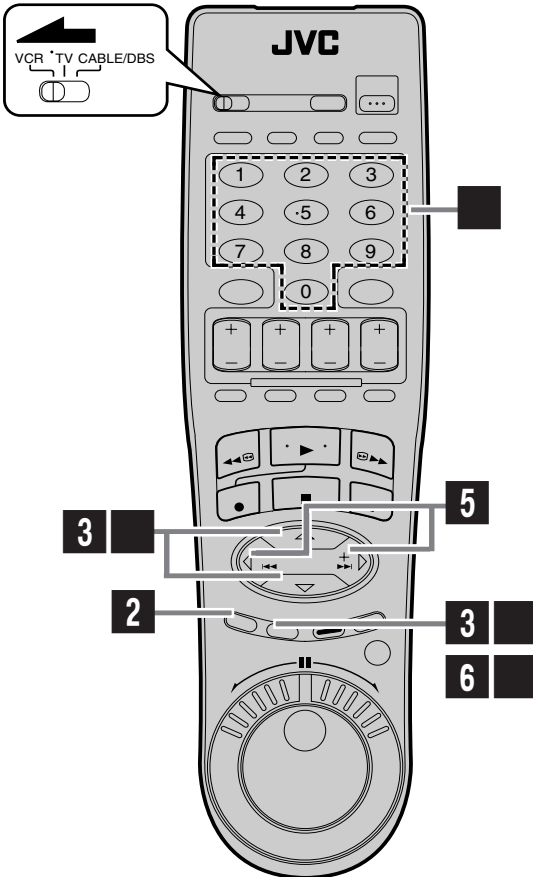

## Setting cable box output channel & brand

After installation, set the cable box output's channel and its brand correctly; otherwise, the Controller cannot work correctly.

### 1 Turn on cable box

Select a channel other than channel 9 on your cable box.

### 2 Access Main Menu screen on VCR

Press **MENU**.

### 3 Access Tuner Set Up screen

Press  $\Delta \nabla$  to move the highlight bar (arrow) to "TUNER SET UP", then press **OK**.

### Access Cable Box Set screen

Press  $\Delta \nabla$  to move the highlight bar (arrow) to "CABLE BOX SET UP", then press **OK**.

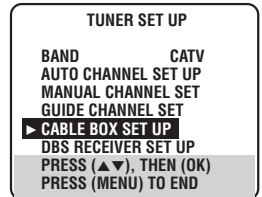

### 5 Select cable box output channel

Your selection depends on how your cable box is connected to your VCR.

- If your cable box is connected to your VCR's **ANTENNA IN** terminal on the rear panel

Press  $\triangleleft \triangleright$  until the channel number representing the cable box's output (CH2 – CH9) appears on the screen.

- If your cable box is connected to your VCR's **AUDIO/VIDEO IN** connectors on the front panel
- Press  $\triangleleft \triangleright$  until "ON F-1 (FRONT)" appears on the screen.

- If your cable box is connected to your VCR's **AUDIO/VIDEO IN (L-1) or AUDIO/VIDEO IN (L-2) connectors on the rear panel**

Press  $\triangleleft \triangleright$  until "ON L-1 (REAR)" or "ON L-2 (REAR)" appears on the screen.

- If you do not use a cable box

Press  $\triangleleft \triangleright$  until "OFF" appears on the screen.

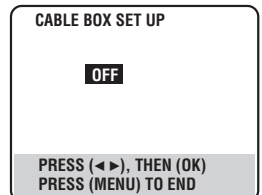

## 6 Access Cable Box Brand Set screen

Press **OK**.

### Enter cable box brand

Press the appropriate **Number** keys to enter the brand code from the list shown to the right, then press **OK**.

- **If the cable box's channel changes to 9, setting is complete**

Press **OK** and "CABLE BOX CONTROL IS ON" appears on the screen for about 5 seconds, then it returns to the normal screen.

- **If the cable box's channel does not change to 9**

- ① Press  $\triangleleft \triangleright$  to move the highlight bar to "NO".
- ② Press **OK**.
- ③ Repeat step ① until the cable box's channel changes to 9 by entering another code.
- ④ If the channel does not change after going through all the code numbers listed for your model of cable box, then try all the other numbers.

CABLE BOX BRAND SET UP

1

PRESS NUMBER KEY (0-9)  
THEN (OK) TO TEST  
PRESS (MENU) TO END

CABLE BOX BRAND SET UP

1

DID YOUR CABLE BOX  
CHANGE TO CHANNEL 09?  
 $\triangleleft$  YES  $\triangleright$  NO

PRESS ( $\triangleleft \triangleright$ ), THEN (OK)  
PRESS (MENU) TO END

## CABLE BOX BRAND LIST

BRAND	CODE
ARCHER	1, 5, 17
CABLETENNA	1, 17
CABLEVIEW	15, 16, 17, 21, 25
CITIZEN	15, 16, 17, 21, 25
CURTIS	2, 8
DIAMOND	1, 17
EASTERN	19
GC BRAND	15, 16, 17, 21, 25
GEMINI	15
GENERAL INSTRUMENTS	1, 4, 6, 11, 12, 15, 28
HAMLIN	10, 18, 19, 23
JASCO	15
JERROLD	1, 4, 6, 11, 12, 15, 28
NOVAVISION	2, 8
OAK	7, 20
PANASONIC	13, 14
PULSER	15, 16, 17, 21, 25
RCA	13, 14
REGAL	10, 18, 19, 23
REGENCY	19
REMBRANDT	1, 16, 17
SAMSUNG	5, 16, 24
SCIENTIFIC ATLANTA	2, 8
SIGMA	7, 20
SL MARX	5, 16, 17, 24, 25
SPRUCER	13, 14
STARGATE	5, 15, 16, 17, 21, 24, 25
TELEVIEW	5, 16, 24
TOCOM	1, 4, 16
UNIKA	1, 17
UNIVERSAL	16, 17, 25
VIDEOWAY	3, 9, 22
ZENITH	3, 9, 22

### If the VCR's clock has not been set (with AUTO CLOCK set to ON)

"CABLE BOX USERS SET CLOCK MANUALLY" appears for about 5 seconds when you press **OK** in step ⑥, then the Clock Set screen appears.

Perform Manual Clock Set on page 12. If you press **MENU** after the clock has been set, the Cable Box Brand Set screen appears.

## NOTES:

- The Controller may not work with all types of cable box.
- If your cable box does not respond to any code, you cannot use the Controller to change cable box channels. In this case, make sure to leave the cable box turned on and tuned to the proper channel before the scheduled start time of timer recording.  
Contact your cable company about the possibility of exchanging your current cable box with the one compatible with your VCR.
- The VCR can only change the cable box channel through the Controller during timer recording.
- If your cable box cannot be operated with a remote control (because it has no remote sensor), you cannot use the Controller to change its channels. Make sure to leave the cable box turned on and tuned to the proper channel before the scheduled start time of timer recording.
- If the VCR's memory backup expires because of a power failure, set the cable box output channel and brand again.
- **For customers in U.S.A.:** If you are unable to set the Controller, contact JVC toll free at 1-800-252-5722.

# DBS Receiver Control Setting

## Suggested location

Place the DBS (Direct Broadcast Satellite) receiver on top of the VCR. Attach the VCR's Controller to the top of the VCR with the Controller's transmitter pointed towards the DBS receiver's remote sensor.

## ATTENTION:

The Controller can also control a cable box. If both a DBS receiver and a cable box are used, position the Controller so its signal reaches the remote sensors on both the DBS receiver and cable box.

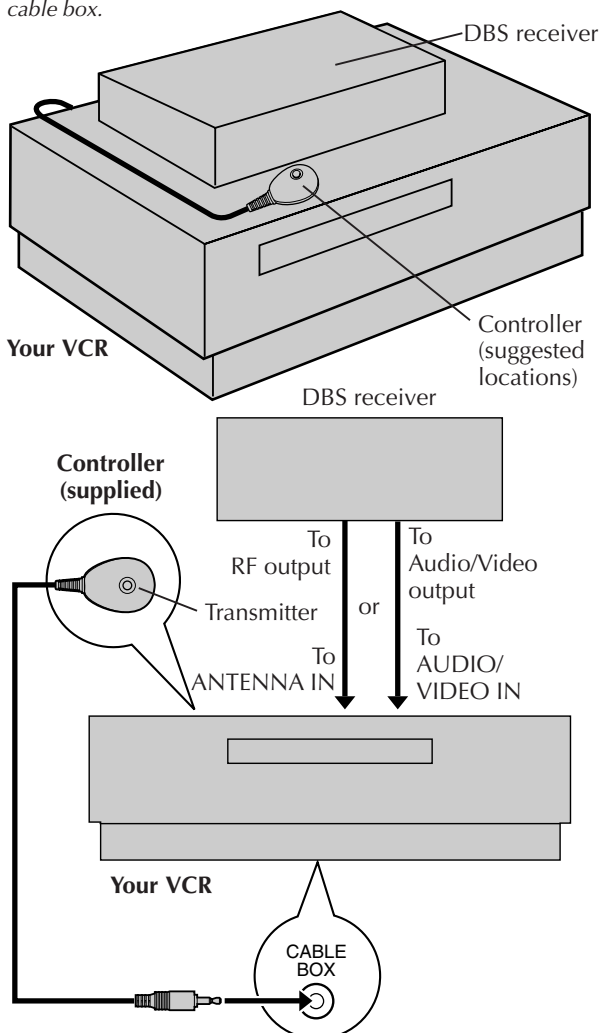

The following procedure is required if you receive satellite channels through a DBS (Direct Broadcast Satellite) receiver. The Controller allows the VCR to automatically switch the DBS receiver's channels during timer recording.

## NOTES:

- The VCR can automatically change the DBS receiver channels using the Controller when the VCR has been programmed using Express timer programming (☞ pg. 38). Because satellite programming does not use PlusCode, the Controller cannot change the DBS receiver channels during VCR Plus+ timer recording. (You can also use "Satellite Auto Recording" (☞ pg. 54) if your DBS receiver is equipped with a timer.)
- If a cable box is also used, it is recommended that you connect the DBS receiver to your VCR's audio/video input connectors and the cable box to your VCR's antenna input terminal.

## Installing Controller

### 1 Situate Controller

Place the Controller so that its transmitter is facing the DBS receiver's remote sensor.

- Make sure the path between the Controller and the DBS receiver's remote sensor is not blocked.

### 2 Attach Controller

Fix securely using the adhesive strip attached on the back of the Controller.

### 3 Connect DBS receiver to VCR

- **If your DBS receiver does not have audio/video output connectors**  
Connect the RF output terminal on the DBS receiver to the ANTENNA IN terminal on the rear of your VCR.
- **If your DBS receiver has audio/video output connectors**  
Connect an audio/video cable between the AUDIO/VIDEO IN connectors on the rear of the VCR and the audio/video output connectors on the DBS receiver.

## NOTE:

When connecting your DBS receiver, refer to its instruction manual.

### Connect Controller to VCR

Connect the Controller to the CABLE BOX Controller connector on the rear panel.

## How to control the DBS receiver

This VCR has two separate methods to control your DBS receiver.

- The VCR's wireless Remote can control your DBS receiver. This eliminates the need for a separate DBS receiver's Remote.
- The VCR's Controller can also control your DBS receiver. This allows the VCR to change your DBS receiver's channel number during timer-recording.

Each method must be set up separately. To set up the VCR's Remote, refer to page 68. To set up the Controller, go to page 19.

Turn on the VCR and the TV, and select the AV mode on the TV.

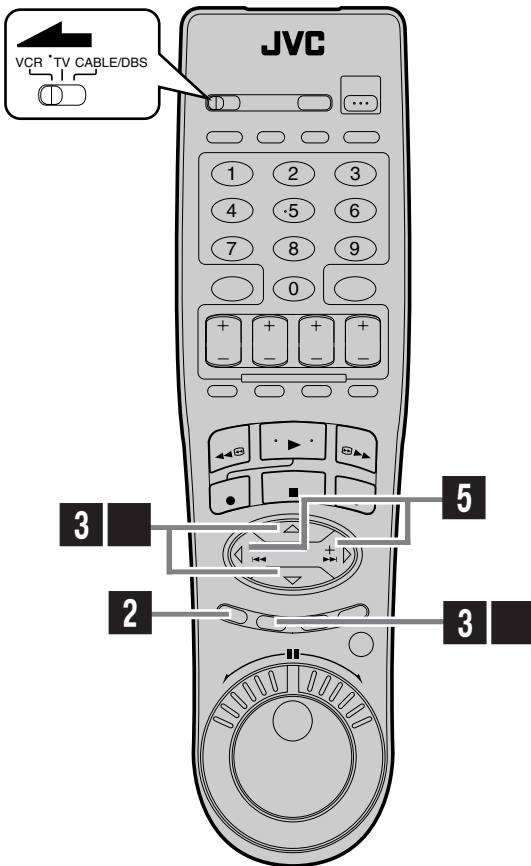

## Setting DBS receiver input channel & brand

After installation, set the DBS receiver's input channel and its brand correctly; otherwise, the Controller cannot work correctly.

### 1 Turn on DBS receiver

Select a channel other than channel 55, 100 or 205 on your DBS receiver.

### 2 Access Main Menu screen on VCR

Press **MENU**.

### 3 Access Tuner Set Up screen

Press  $\Delta$ / $\nabla$  to move the highlight bar (arrow) to "TUNER SET UP", then press **OK**.

### Access DBS Receiver Set screen

Press  $\Delta$ / $\nabla$  to move the highlight bar (arrow) to "DBS RECEIVER SET UP", then press **OK**.

#### TUNER SET UP

BAND CATV  
 AUTO CHANNEL SET UP  
 MANUAL CHANNEL SET  
 GUIDE CHANNEL SET  
 CABLE BOX SET UP  
 ► **DBS RECEIVER SET UP**  
 PRESS ( $\Delta$ / $\nabla$ ), THEN (OK)  
 PRESS (MENU) TO END

### 5 Select DBS receiver input channel

Your selection depends on how your DBS receiver is connected to your VCR.

- **If your DBS receiver is connected to your VCR's ANTENNA IN terminal on the rear panel**

Press  $\triangleleft$ / $\triangleright$  until the channel number representing the DBS receiver's output (CH3 or CH4) appears on the screen.

- **If your DBS receiver is connected to your VCR's AUDIO/VIDEO IN connectors on the front panel**

Press  $\triangleleft$ / $\triangleright$  until "ON F-1 (FRONT)" appears on the screen.

- **If your DBS receiver is connected to your VCR's AUDIO/VIDEO IN (L-1) or AUDIO/VIDEO IN (L-2) connectors on the rear panel**

Press  $\triangleleft$ / $\triangleright$  until "ON L-1 (REAR)" or "ON L-2 (REAR)" appears on the screen.

- **If you do not use a DBS receiver**

Press  $\triangleleft$ / $\triangleright$  until "OFF" appears on the screen.

#### DBS RECEIVER SET UP

**OFF**

PRESS ( $\triangleleft$ / $\triangleright$ ), THEN (OK)  
 PRESS (MENU) TO END

CONTINUED ON NEXT PAGE ➔

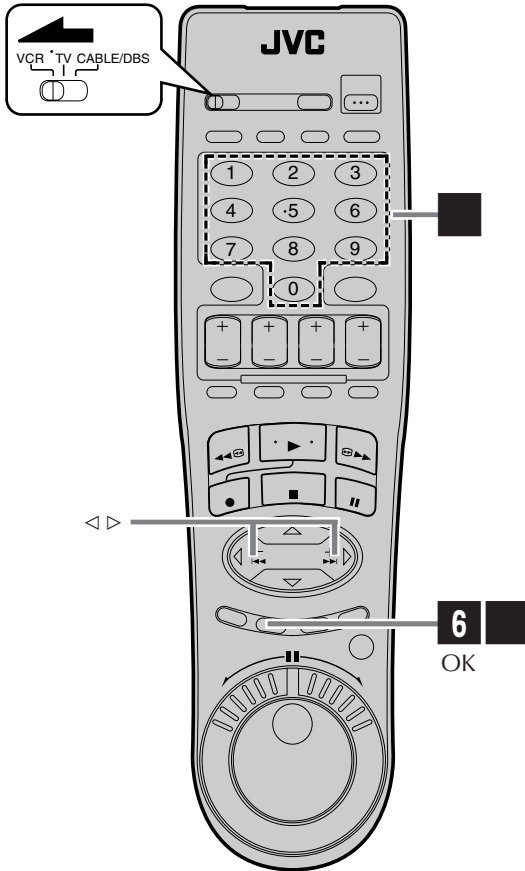

## 6 Access DBS Receiver Brand Set screen

Press **OK**.

## Enter DBS Receiver's brand

Press the appropriate **Number** keys to enter the brand code from the following list, then press **OK**.

The program currently received through the DBS receiver appears for about 10 seconds.

DBS RECEIVER BRAND SET

40

PRESS NUMBER KEY (0-9)  
THEN (OK) TO TEST  
PRESS (MENU) TO END

BRAND	CODE
JVC (DISH Network)	51
ECHOSTAR (DISH Network)	51
PRIMESTAR	50
SONY (DSS)	41
RCA (DSS)	40

- If the DBS receiver's channel changes to the channel listed below for your brand, setting is complete

JVC → 100  
ECHOSTAR → 100  
PRIMESTAR → 55  
SONY → 205  
RCA → 205

Press **OK** and "DBS RECEIVER CONTROL IS ON" appears on the screen for about 5 seconds, then it returns to the normal screen.

DBS RECEIVER BRAND SET

51

DID YOUR DBS RECEIVER  
CHANGE TO CHANNEL 100?  
◀ YES ▶ NO

PRESS (◀▶), THEN (OK)  
PRESS (MENU) TO END

- If the DBS receiver's channel does not change as shown above
  - ① Press ◀▶ to move the highlight bar to "NO".
  - ② Press **OK**.
  - ③ Re-enter the correct code.

## NOTES:

- The Controller may not work with all types of DBS receiver.
- If your DBS receiver does not respond to the code, you cannot use the Controller to change satellite channels. In this case, make sure to leave the DBS receiver turned on and tuned to the proper channel before the scheduled start time of timer recording. In addition, if your DBS receiver is equipped with a timer, you can also use "Satellite Auto Recording" (☞ pg. 54).
- The VCR can only change the satellite channel through the Controller during timer recording.
- If your DBS receiver cannot be operated with a remote control (because it has no remote sensor), you cannot use the Controller to change its channels. Make sure to leave the DBS receiver turned on and tuned to the proper channel before the scheduled start time of timer recording.
- **For customers in U.S.A.:** If you are unable to set the Controller, contact JVC toll free at 1-800-252-5722.

# Basic Playback

Turn on the VCR and the TV, and select the AV mode on the TV.

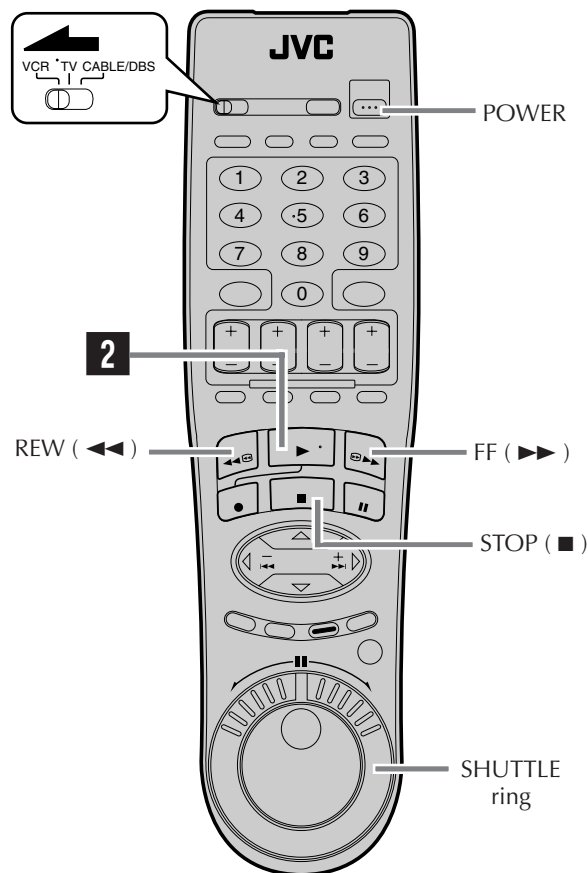
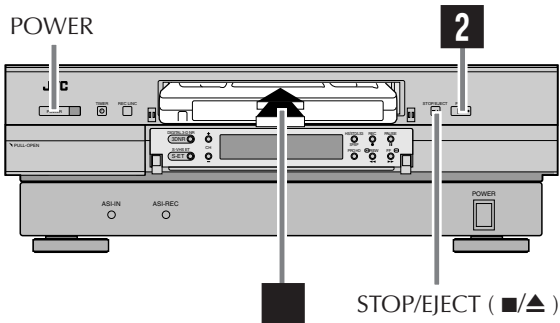

This VCR can check the tape condition during playback (and recording), and realizes the best possible pictures.

- This recorder can play back tapes that have been recorded in D-VHS (MTP), S-VHS and VHS formats.
- When playing back a tape, this recorder automatically identifies the recording format (D-VHS, S-VHS, or VHS).

## Load a cassette

Make sure the window side is up, the rear label side is facing you and the arrow on the front of the cassette is pointing towards the VCR. Do not apply too much pressure when inserting.

- The VCR turns on automatically.
- The counter is automatically reset to "0:00:00".
- The tape will run for a few seconds while the VCR searches for the tape number. If the tape number is found, it will be shown on the TV screen if "SUPERIMPOSE" is set to "ON." (☞ pg. 52)
- If the cassette's record safety tab has been removed, playback begins automatically.

## 2 Start playback

Press **PLAY (▶)**.

- Tape speed is automatically detected.
- If "V, CALIBRATION" is set to "ON" (default setting: ☞ pg. 49), "V, CALIBRATION" appears on the screen, and this VCR checks the tape condition during automatic tracking (only cassettes recorded in the S-VHS or VHS mode).

### To stop playback

Press **STOP (■)** on the Remote or **STOP/EJECT (■/▲)** on the front panel.

### To rewind the tape (when it is not running)

Press **REW (◀◀)**.

### To fast-forward (when it is not running)

Press **FF (▶▶)**.

### To eject the tape

Press **STOP/EJECT (■/▲)** on the front panel when the tape is not running.

- You can also eject the cassette when the VCR is turned off.

### To turn off the VCR

Press **POWER**.

### NOTES:

- When you use the Video Navigation function, operate the VCR only after the tape number is detected; otherwise, you cannot use the Video Navigation function.
- When playing back a tape recorded in D-VHS format, the **JOG** dial and **SHUTTLE** ring do not work.

# Basic Playback Features

Turn on the VCR and the TV, and select the AV mode on the TV.

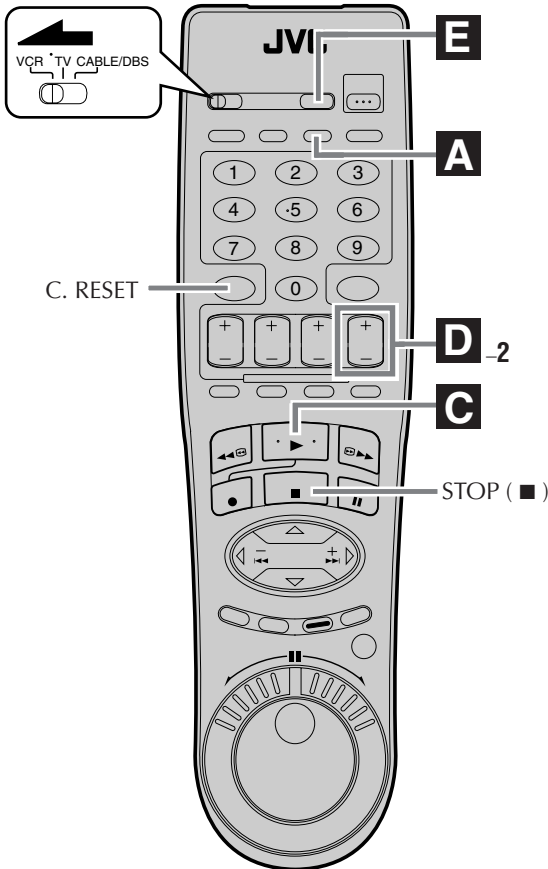
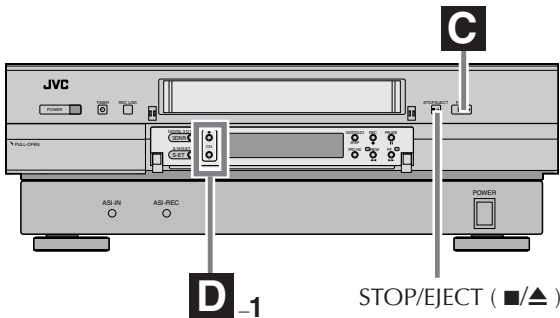

## A Changing display information

Press **DISPLAY** during playback.

Each time you press the button, the front display panel shows the time counter, the clock time and the tape remaining time in sequence.

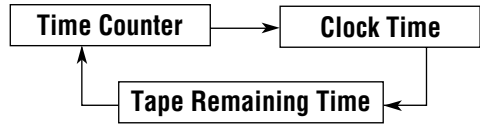

- To display the VCR status including the time counter and the clock time on the TV screen, see “Showing on-screen display” (pg. 29).
- “COUNT” appears on the screen when the time counter is shown. “REMAIN” appears on the screen when the tape remaining time is shown.
- When the tape remaining time appears, “▶” also lights on the front display panel.
- The tape remaining time is calculated based on the tape speed being used. The indicated remaining time is only an estimate.

To reset the time counter, press **C. RESET** on the Remote. The counter reading becomes “0:00:00”. It is also reset when a tape is inserted.

## B Checking tape position

The tape position indicator appears on the screen in the following cases:

- When you change the VCR operation mode from the stop mode to fast forward or rewind mode.
- When you perform an Index Search (pg. 24) or Instant Review (pg. 25).

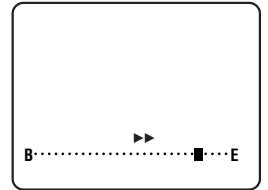

The position of “■” in relation to “B” (Beginning) or “E” (End) shows you where you are on the tape.

### NOTES:

- “SUPERIMPOSE” must be set to “ON”, or the indicator will not appear (pg. 52).
- It may take a few seconds for the tape position indicator to be displayed.



## C Playing back tape repeatedly

### — Repeat Playback

You can play back a tape repeatedly (50 times).

**While playing back a tape, press and hold PLAY (▶) for more than 5 seconds.**

The play indicator (▷) on the front display panel starts flashing slowly, and a tape will be played back 50 times.

**To stop playback, press STOP (■) on the Remote or STOP/EJECT (■/▲) on the front panel.**

### NOTE:

For a cassette recorded in D-VHS mode, Repeat Playback is possible only if the cassette was recorded in STD mode.

## D Adjusting tracking condition

### — Tracking Adjustments

#### Automatic tracking adjustment

This VCR automatically adjusts the tracking condition. Whenever you insert a tape and start playback, automatic tracking starts working and continuously analyzes the signal to enable optimum picture quality during playback.

#### Manual tracking adjustment

If automatic tracking cannot eliminate noises well during playback, use the manual tracking following the procedures below.

- You can also use the manual tracking during slow motion playback (☞ pg. 33).

### 1 Activate manual tracking

Press **CH +** and **-** on the front panel at the same time during playback.

### 2 Eliminate the noises on the TV screen.

Press **CH +** or **-**.

- Press it briefly for a fine adjustment, or press and hold for a coarse adjustment. Watch the screen and continue adjustment until optimum picture and sound quality are achieved.
- To reactivate automatic tracking, press **CH +** and **-** on the front panel at the same time. The automatic tracking becomes active again.

## E Selecting monitor sound

### — Audio Monitor

You can select the desired monitor sound.

**While playing back a tape on which stereo sound or SAP sound is recorded, press A. MONITOR on the Remote.**

Each time you press the button, sound changes as follows:

#### S-VHS/VHS

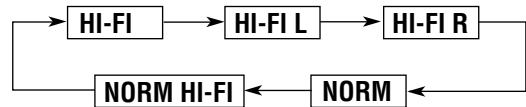

HI-FI: Normally select this.  
Hi-Fi sound is played back.  
HI-FI L: Sound on the left Hi-Fi channel is played back.  
HI-FI R: Sound on the right Hi-Fi channel is played back.  
NORM: Sound on the normal track is played back.  
NORM HI-FI:  
Both sounds on the Hi-Fi track and normal track are mixed and played back.

#### D-VHS



HI-FI: Normally select this.  
HI-FI L: Sound on the left Hi-Fi channel is played back.  
HI-FI R: Sound on the right Hi-Fi channel is played back.

### NOTES:

- The above indication appears when "SUPERIMPOSE" is set to "ON" (☞ pg. 56), though the monitor sound changes in sequence.
- If the tape being played back has no Hi-Fi sound track, the normal sound track will be heard regardless of this setting.

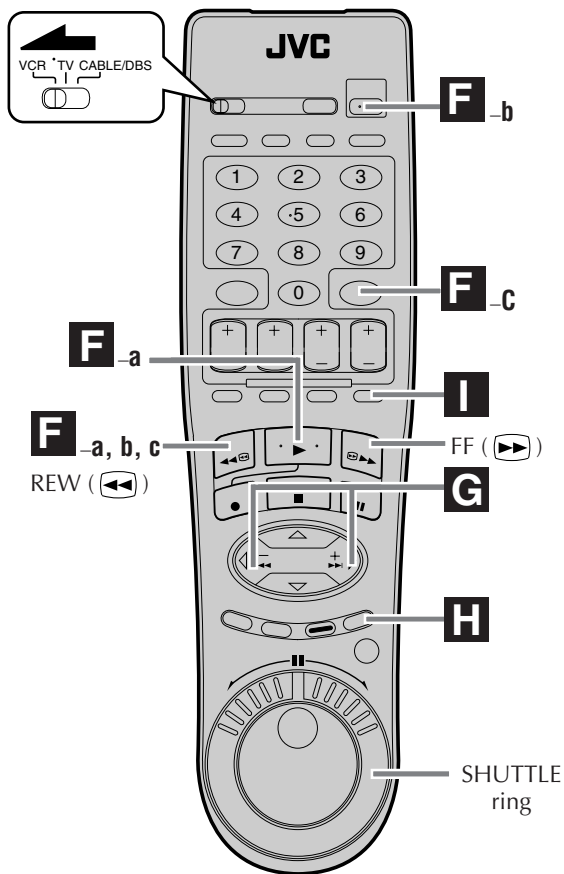
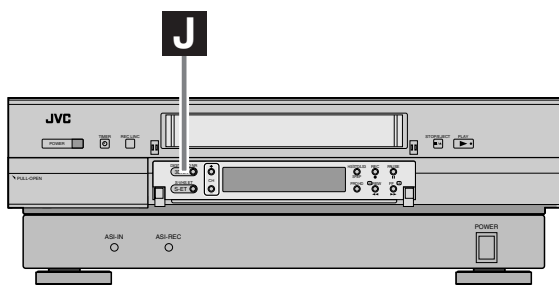

## F Automatic operations after rewinding — Next Function Memory

The Next Function Memory “tells” the VCR what to do after rewinding is complete.

- Ensure that the VCR is in stop mode.

### a- For Automatic Playback Start

Press **REW** (◀◀), then press **PLAY** (▶) within 2 seconds.

### b- For Automatic Power Off

Press **REW** (◀◀), then press **POWER** within 2 seconds.

### c- For Automatic Timer Standby

Press **REW** (◀◀), then press **TIMER** within 2 seconds.

### NOTE:

It is not possible to select the Automatic Timer Standby function if the cassette's record safety tab is removed.

## G Locating beginning of recordings — Index Search

Index codes are placed on the tape at the beginning of each recording when recording on this VCR. You can find and automatically play back from the beginning of any recording using the Index Search function.

### 1 Start search

While the tape is not running, press ◀◀ or ▶▶ on the Remote.

### 2 Access distant code

To access a recording of 2 to 9 index codes away, press ◀◀ or ▶▶ repeatedly until the correct number is displayed on the screen (only if “SUPERIMPOSE” is set to “ON” ; pg. 52). Playback begins automatically when the desired recording is located.

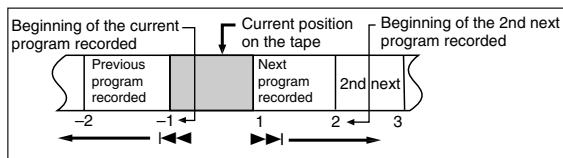

- If you want to find the very beginning of the desired program, press **REW** (◀◀) or **FF** (▶▶) or turn the **SHUTTLE** ring after playback starts.

### NOTE:

An index code is not placed on the tape when recording is resumed from recording pause.

## **H** Locating beginning of timer recordings — Instant Review

At the press of a button, you can turn on the VCR, rewind the tape and begin to view the most recent timer-recorded program.

**Press REVIEW on the Remote after ensuring that the VCR is in the timer recording standby mode.**

- The VCR turns on, and rewinds to the index code indicating the beginning of the last timer-recorded program, then begins playback automatically.
- You can access a program of 2 to 9 index codes away from the current position on the tape. If, for example, you have 5 programs recorded and you want to watch the third one, press **REVIEW** three times.
- If you want to find the very beginning of the desired program, press **REW** (◀◀) or **FF** (▶▶) or turn the **SHUTTLE** ring after playback starts.
- If the tape is already rewound when **REVIEW** is pressed, it will play the tape from the beginning. It will not fast-forward to an index code.
- The Instant Review function will also operate if the VCR is turned on.

## **I** Skipping unwanted portions — Skip Search

You can skip over (view at high speed) unwanted portions of the tape.

**Press SKIP SEARCH on the Remote once to 4 times during playback.**

Each press initiates a 30-second period of high speed playback (up to 2 minutes). When the specified portion of the tape is skipped, normal playback resumes automatically.

**To return to normal playback during Skip Search, press PLAY (▶).**

## **J** Adjusting picture condition — Digital 3-DNR (S-VHS/VHS only)

The Digital 3-DNR (3-Dimension Noise Reduction) cuts noise and reproduces clear pictures. Normally turn on Digital 3-DNR.

The playback picture may be distorted depending on the tape. In this case, turn off Digital 3-DNR.

**Press DIGITAL 3-DNR on the front panel so that the DIGITAL 3-DNR lamp lights up.**

Each time you press the button, this function turns on and off.

### Other Useful functions for playback (S-VHS/VHS only)

You can also use the following functions for playback.

- **Video Calibration (S-VHS/VHS only)** (☞ pg. 49)  
When this function is set to "ON", this VCR checks the condition of the tape in use during playback and recording, and compensates to provide the highest-possible pictures.
- **Picture Control** (☞ pg. 49)  
This function helps you to adjust the playback picture quality according to your preference.
- **Digital R3** (☞ pg. 49)  
This function applies edge correction to the luminance signal to enhance details and provides clear pictures.
- **Video Stabilizer** (☞ pg. 49)  
You can automatically correct vertical vibrations in the picture when playing back unstable recordings made on another VCR.

# Basic Recording

Turn on the VCR and the TV, and select the AV mode on the TV.

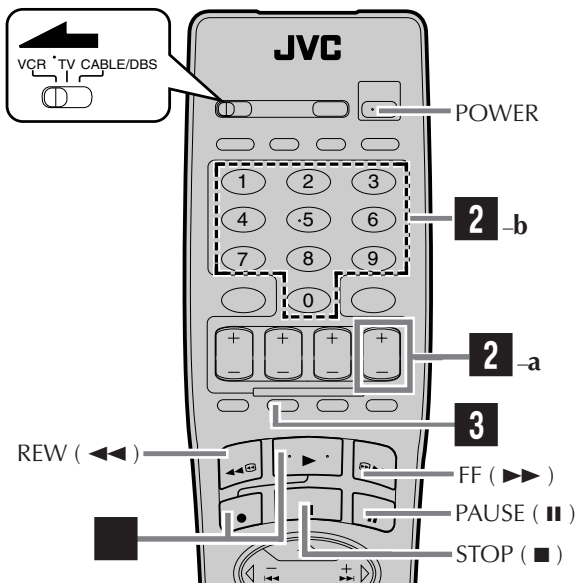
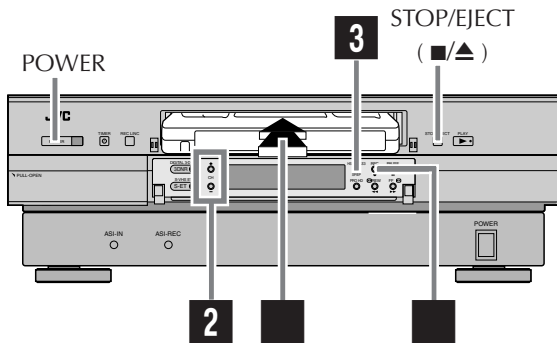

## S-VHS/VHS Recording

### 1 Load a cassette

Make sure the record safety tab is intact. If not, cover the hole with adhesive tape before inserting the cassette.

### 2 Select recording channel

**On the front panel:**

Press CH + or –.

**On the Remote:**

a– Press CH + or –.

or

b– Press the **Number** keys.

### 3 Set tape speed

Press HS/STD/LS3/SP/EP ( // ) to set the recording speed.

### Start recording

**On the front panel:**

Press REC ( ● ).

**On the Remote:**

While holding REC ( ● ), press PLAY ( ► ).

- If “V, CALIBRATION” is set to “ON” (default setting: pg. 49), this VCR checks the tape condition for about seven seconds, then starts recording. This means that the first seven seconds of the program will not be recorded. If this is inconvenient for you, follow the steps below:

- Press REC ( ● ) and PAUSE ( || ) to start Video Calibration.
- Then press PLAY ( ► ) to start recording after Video Calibration is complete.

It may be unlawful to record or play back copyrighted material without the consent of the copyright owner.

**To pause recording**

Press **PAUSE** (■). To resume recording, press **PLAY** (▶).

**To stop recording**

Press **STOP** (■) on the Remote or **STOP/EJECT** (■/▲) on the front panel.

**To rewind the tape (when it is not running)**

Press **REW** (◀◀).

**To fast-forward the tape (when it is not running)**

Press **FF** (▶▶).

**To eject the tape**

Press **STOP/EJECT** (■/▲) on the front panel when the tape is not running.

- You can also eject the cassette when the VCR is turned off.

**To turn off the VCR**

Press **POWER**.

**Compatibility Of Cassettes And Recording Mode**

Cassette	Recording Mode	
	S-VHS	VHS
D-VHS	Yes	Yes
S-VHS	Yes	Yes
VHS	Yes*	Yes

\* To record on the VHS cassette with S-VHS quality, use the S-VHS ET function. (☞pg. 29)

**NOTES:**

- The S-VHS and VHS mode recordings are possible with this VCR.
- To record in the S-VHS/VHS mode, you can use a D-VHS, S-VHS or VHS cassette.

**To record in S-VHS mode on D-VHS tapes:**

Set "S-VHS MODE" to "ON" (☞ pg. 53).

**To record in VHS mode on D-VHS tapes:**

Set "S-VHS MODE" to "OFF" (☞ pg. 53).

# Basic Recording Features

Turn on the VCR and the TV, and select the AV mode on the TV.

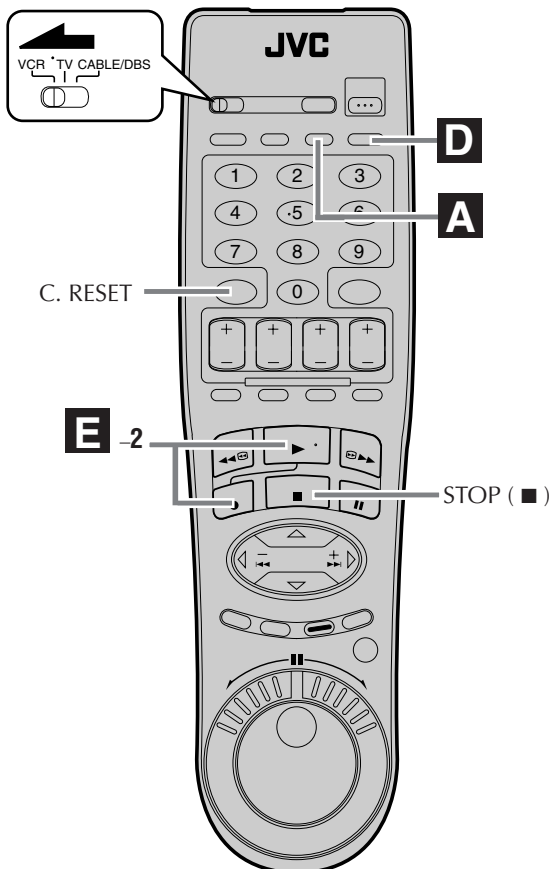
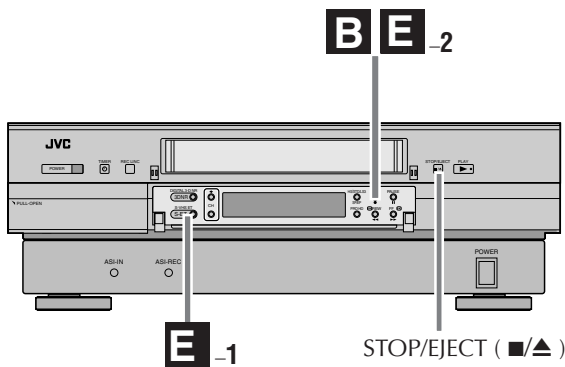

## A Changing display information

Press **DISPLAY** during recording or recording pause. Each time you press the button, the front display panel shows the time counter, channel number, clock time, and the tape remaining time in sequence.

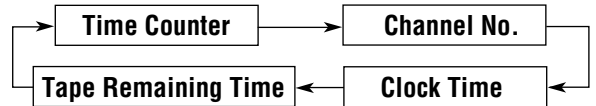

- To display the VCR status including the time counter and the clock time on the TV screen, see “Showing on-screen display” (pg. 29).
- “COUNT” appears on the screen when the time counter is shown. “REMAIN” appears on the screen when the tape remaining time is shown.
- When the tape remaining time appears, “▶” also lights on the front display panel.
- The tape remaining time is calculated based on the tape speed being used. The indicated remaining time is only an estimate.

To reset the time counter, press **C. RESET** on the Remote. The counter reading becomes “0:00:00”. It is also reset when a tape is inserted.

## B Specifying recording length

### — Instant Timer Recording (ITR)

You can easily specify the recording length from 30 minutes to 8 hours and the VCR shuts off after recording is finished.

During recording, press **REC (●)** on the front panel repeatedly until the recording length you want appears on the front display panel.

The record (○) indicator starts flashing. Each time you press the button, recording length increases in 30-minute intervals (up to 8 hours).

To cancel an ITR, press **STOP (■)** on the Remote or **STOP/EJECT (■/▲)** on the front panel.

## C Watching one program while recording another

### 1 Engage TV mode

During recording...

- Change the TV's input mode from AV to TV.

### 2 Select channel for viewing

Select the channel you want to watch, on the TV.

## D Showing on-screen display

When "SUPERIMPOSE" is set to "ON" (☞ pg. 56), you can see the current VCR status on the TV screen.

- For more detailed information about the on-screen display, see page 79.

### 1 Display VCR status on TV screen

During recording or recording pause, press **OSD** on the Remote.

All indications corresponding to the current VCR status are displayed for 5 seconds.

The time counter remains on the screen indicating the elapsed time.

- The indications are not recorded.

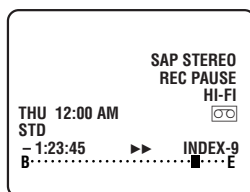

### 2 Exit on-screen display

Press **OSD** again.

#### NOTES:

- If the VCR is in recording pause mode, "REC PAUSE" is always displayed.
- The VCR status can be also displayed during playback.

## E Recording on VHS tapes with S-VHS quality — Super VHS ET

This function allows you to record on VHS tapes with S-VHS picture quality. Tapes recorded using this function can be played back only on a VCR equipped with the S-VHS ET function.

- You can activate this function only before you start recording on a VHS tape.
- Before recording, make sure "V, CALIBRATION" is set to "ON" (☞ pg. 49).

### 1 Select S-VHS ET mode

Press **S-VHS ET** on the front panel. The S-VHS ET lamp lights up.

- To disengage the S-VHS ET mode, press **S-VHS ET** again. The lamp goes off.

### 2 Start recording

**On the front panel:**

Press **REC** (●).

**On the Remote:**

While holding **REC** (●), press **PLAY** (▶).

#### NOTES:

- You cannot activate the S-VHS ET function...
  - while recording is in progress.
  - while timer-recording or Instant Timer Recording (☞ pg. 28) is in progress.
  - while Video Calibration (☞ pg. 53) is in progress.
- S-VHS ET does not work with S-VHS tapes.
- To keep the highest quality recording and playback pictures over a long period of time, S-VHS recording on S-VHS tapes is recommended.
- Use of high grade tapes are recommended for S-VHS ET recordings.
  - On some tapes, picture quality will not improve even if the S-VHS ET function is used. Check the recording quality before you start important recordings.
- You can play back S-VHS ET recordings on most of S-VHS VCRs and of VHS VCRs equipped with SQPB (S-VHS QUASI PLAYBACK) function. (Notice some VCRs are not compatible with this function.)
- While playing back a tape recorded with this function, noise may appear. (If playback picture becomes blurred or interrupted, use a cleaning cassette.)
- During special effect playback (☞ pg. 31), noise may appear. If special effect playback is performed frequently on a tape recorded with this function, the tape may be damaged and picture may be deteriorated.



### Other useful functions for recording

You can also use the following functions for recording.

#### ● Recording Resume Function

If there is a power outage during recording (including Instant Timer Recording, timer recording and Satellite Auto Recording), the recording will resume automatically when the power is restored to the VCR. (No setting is required for this function.)

#### ● Video Calibration (S-VHS/VHS only) (☞ pg. 49)

When this function is set to "ON", this VCR checks the condition of the tape in use during playback and recording, and compensates to provide the highest-possible pictures.

#### ● Second Audio Recording (☞ pg. 50)

This VCR's built-in MTS decoder enables reception of Multichannel TV Sound broadcast.

To record a SAP program received, set "2ND AUDIO REC" to "ON" using the menu screen.

### NOTES:

*When the channel is changed on the VCR;*

- The "STEREO" indication appears on the screen for about 5 seconds if the program is a stereo broadcast.
- The "SAP" indication appears on the screen for about 5 seconds if the program is a SAP broadcast.
- Both indications appear when a stereo program is accompanied by SAP sound.

#### ● S-VHS Recording Mode (☞ pg. 53)

This VCR allows you to record on a D-VHS and S-VHS tape with VHS picture quality.

### Accidental erasure prevention

To prevent accidental recording on a recorded cassette, remove its record safety tab.

To record on it later, cover the hole with adhesive tape.

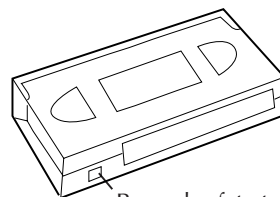

Record safety tab

# Special Effect Playback

Turn on the VCR and the TV, and select the AV mode on the TV.

## ATTENTION

When playing back a tape recorded in PRO HD (based on D-VHS) format, the **JOG** dial and **SHUTTLE** ring do not work.

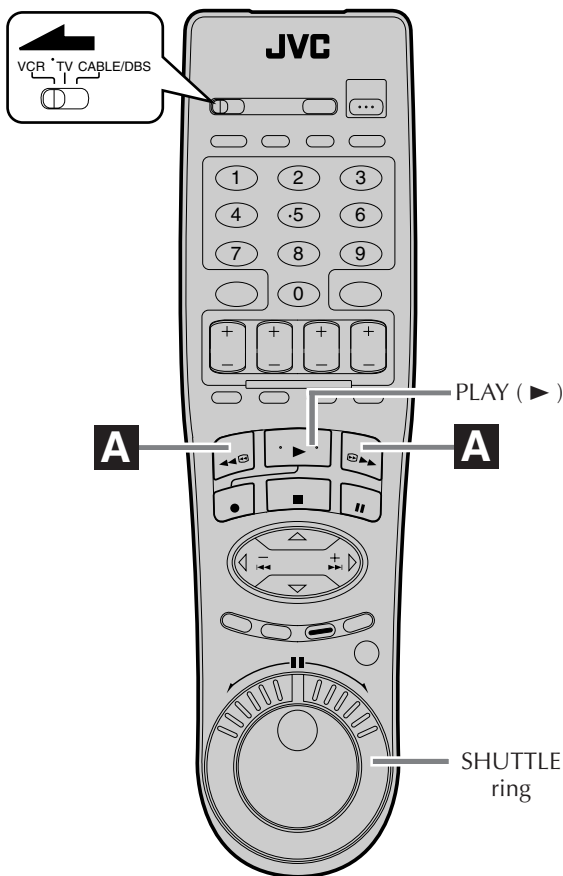

## NOTE:

To use the **JOG** dial/**SHUTTLE** ring on the Remote, first press **JOG**/**SHUTTLE** on the remote control so that the button lights up.

With this VCR, you can enjoy special effect playback such as high-speed search, variable-speed search, and still playback and so on.

## A Locating particular scene rapidly — Picture Search

### ■ High-Speed Picture Search:

Possible during normal playback or still picture playback.

You can rapidly locate a particular scene on the tape.

**To do forward picture search**, turn the **SHUTTLE** ring fully to the right. When you release the ring, a still picture appears.

**To do reverse picture search**, turn the **SHUTTLE** ring fully to the left. When you release the ring, a still picture appears.

- If you turn the ring fully and release it within 1 second, a still picture appears.

### OR

**To do forward picture search**, press **FF** (▶▶).

**To do reverse picture search**, press **REW** (◀◀).

- If you press and hold the button for more than 2 seconds, simply releasing it cancels the picture search, and normal playback resumes.

**To resume normal playback**, press **PLAY** (▶).

## NOTES:

- The high-speed picture search speed of the PRO HD (based on D-VHS) recording is 6 times normal playback speed in HS mode, 12 times in STD mode, 36 times in LS3 mode. The high-speed picture search speed of the S-VHS/VHS recording is 11 times normal playback speed in SP mode, 31 times in EP mode.
- The picture may be distorted at the part where the playback speed is changed.
- The still picture may appear during the high-speed picture search of a tape recorded in PRO HD (based on D-VHS) format on other devices.

### ■ Variable-Speed Picture Search (S-VHS/VHS only):

You can change the speed of picture search.

Turn the **SHUTTLE** ring to the right (forward search) or to the left (reverse search).

As you turn the **SHUTTLE** ring, picture search speed changes (see the diagram on page 32).

When you release the ring, a still picture appears.

- The speed of picture search is determined by the rotating angle of the **SHUTTLE** ring.

**To resume normal playback**, press **PLAY** (▶).

To use the **JOG** dial/**SHUTTLE** ring on the Remote, first press **JOG/SHUTTLE** on the remote control so that the button lights up.

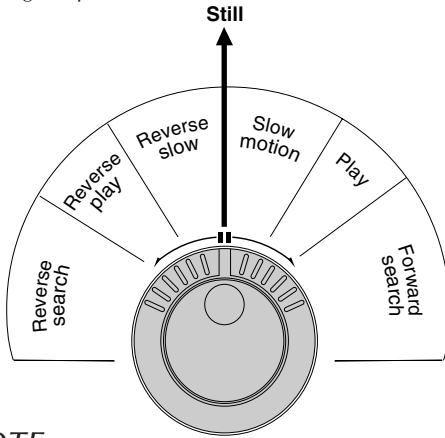
**NOTE:**

When playing back a tape recorded in PRO HD (based on D-VHS) format, the **JOG** dial and **SHUTTLE** ring do not work.

**B** Viewing still picture

## — Still Picture Playback

Press **PAUSE** ( **||** ) during normal playback.

Playback is frozen and a still picture appears.

To resume normal playback, press **PLAY** ( **▶** ).

**NOTE:**

To obtain a noiseless still picture, it may be necessary to adjust tracking in slow motion playback before starting still picture playback.

**C** Viewing still picture frame by frame

## — Frame-by-Frame Playback (S-VHS/VHS only)

**1** Pause during playback

Press **PAUSE** ( **||** ).

Playback is frozen and a still picture appears.

**2** Advance or reverse still picture

To advance a still picture, turn the **JOG** dial to the right.

To reverse a still picture, turn the **JOG** dial to the left.

**OR**

To advance a still picture, press **▶▶** (or **PAUSE** ( **||** )) repeatedly.

To reverse a still picture, press **◀◀** repeatedly.

To resume normal playback, press **PLAY** ( **▶** ).

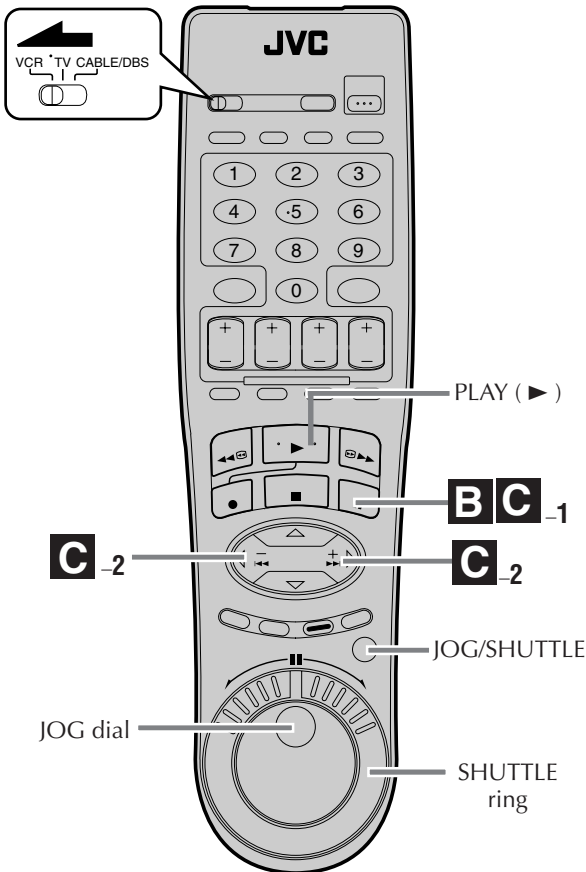

## D Viewing slow motion picture

### — Slow Motion Playback (S-VHS/VHS only)

#### During normal playback or still picture playback:

Turn the **SHUTTLE** ring slowly to the right (forward slow motion) or to the left (reverse slow motion) so that slow motion playback starts. When you release the ring, a still picture appears.

- Holding **PAUSE ( || )** for more than 2 seconds also starts forward slow motion playback. If you press **PAUSE ( || )** again, still picture resumes.

#### During normal playback:

Press **◀◀** to decrease the playback speed.

Each time you press the button, the speed decreases (toward reverse slow motion playback, then reverse picture search).

- Holding **PAUSE ( || )** for more than 2 seconds also starts forward slow motion playback. If you press **PAUSE ( || )** again, still picture resumes.

To resume normal playback, press **PLAY ( ▶ )**.

#### During still picture playback:

Press and hold **▶▶** to start forward (or **◀◀** to start reverse) slow motion playback. When you release the button, slow motion playback stops and a still picture appears.

- Holding **PAUSE ( || )** for more than 2 seconds also starts forward slow motion playback. If you press **PAUSE ( || )** again, still picture resumes.

To resume normal playback, press **PLAY ( ▶ )**.

### NOTE:

Manual tracking is possible during slow motion playback.

During slow motion playback, simply press **CH +** or **-** to adjust tracking.

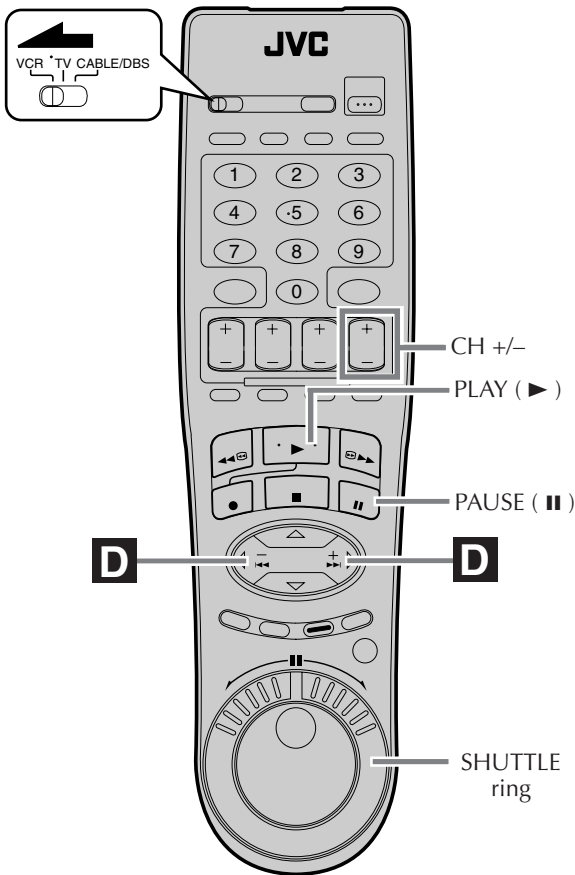

# VCR Plus+® Timer Programing

Turn on the VCR and the TV, and select the AV mode on the TV.

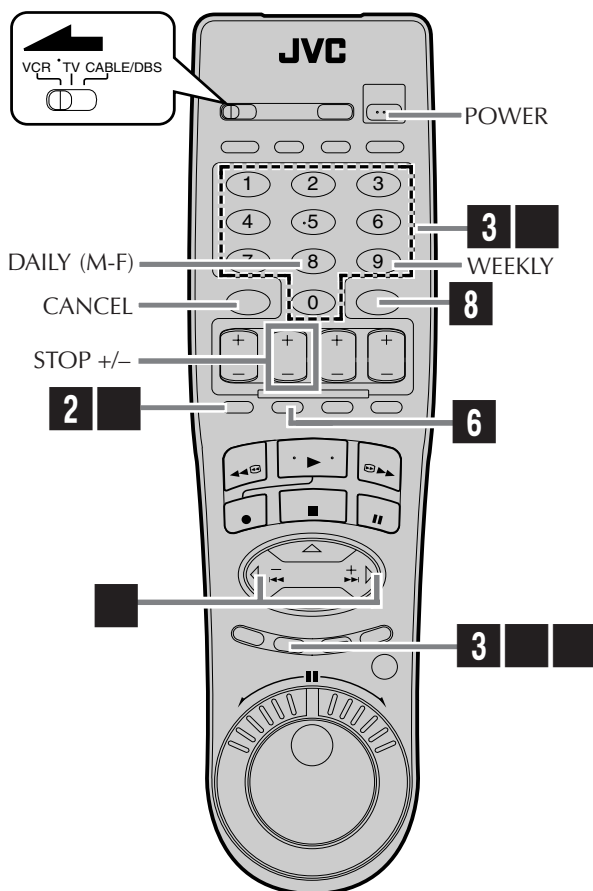
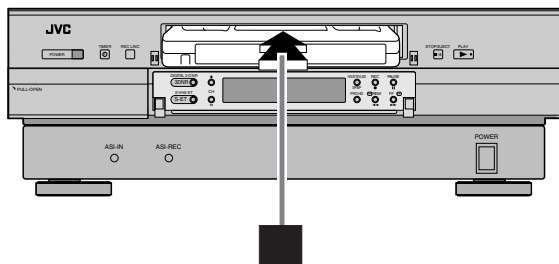

Timer recording allows you to program the VCR to automatically record a broadcast at some future time. Up to 24 timer recording programs can be made using VCR Plus+ timer programming or Express timer programming method (see pg. 38) as far as a year in advance.

The VCR Plus+ timer programming system eliminates the need to input channel, date, start and stop time data when programming timer recording settings. Simply key in the PlusCode number for the TV broadcast you wish to record and the VCR's timer will be automatically programmed. (The PlusCode programming numbers are the numbers next to the program in most TV listing.)

## 1 Load a cassette

Make sure the record safety tab is intact. If not, cover the hole with adhesive tape, then load it into the VCR.

- The VCR turns on, and the counter is reset, automatically.

## 2 Access VCR Plus+ screen

Press **PROG.** on the Remote.

- The clock must be set to access the VCR Plus+ screen. If you have not set the clock, the Main Menu screen appears after an error message is displayed. Refer to page 9 for the Plug & Play setting or page 10 for the clock setting procedure.

PLUSCODE NUMBER



PRESS NUMBER KEYS (0-9)  
PRESS (+/-) TO SET  
EXPRESS PROGRAMMING  
PRESS (PROG.) TO END

## 3 Enter PlusCode number

Press the appropriate **Number** keys to input the PlusCode number printed in the TV listings for the TV broadcast you wish to record, then press **OK**.

PLUSCODE NUMBER



PRESS NUMBER KEYS (0-9)  
THEN (OK)  
PRESS (PROG.) TO END

Then;

If the Guide Channel Set screen appears  
— go to step **1**.

If the VCR Plus+ Program screen appears  
— go to step **5**.

- To make corrections, press **CANCEL** and input the correct PlusCode number.

## Input receiving channel number

The guide channel number, which is assigned to the TV or cable station for the PlusCode number that you entered in step 3, will appear automatically on the Guide Channel Set Up screen.

Press the **Number** keys (or < >) to input the number of the channel on which the broadcast for the PlusCode number is received on the VCR or cable box, then press **OK**.

- The Guide Channel Set screen appears only when you input the PlusCode number of a station for which the guide channel number has not been set previously.
- If you receive your channels with a cable box and if you have properly set your Controller, "CABLE CH" appears in place of "VCR CH". If not, refer to pages 15 – 17.

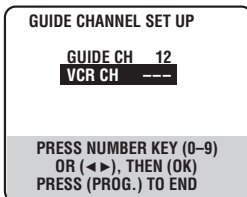

## 5 Check program date

The PlusCode number you entered and the corresponding timer recording program is displayed on the Program screen. Check to make sure it is accurate.

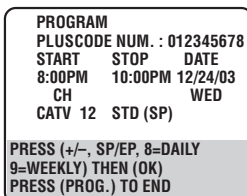

- To change the stop time, press **STOP +/-**.
- To timer-record daily (Monday–Friday) or weekly serials, press **DAILY (M-F)** (number "8") or **WEEKLY** (number "9"). "DAILY" or "WEEKLY" appears on the Program screen. Pressing the button again makes each corresponding display disappear.
- If you made a mistake, press **CANCEL** to access the VCR Plus+ screen again and input the correct PlusCode number.
- If an incorrect PlusCode number or the one for a broadcast already finished has been inputted, "ERROR" is displayed for about 5 seconds, then the VCR Plus+ screen reappears.

## 6 Set tape speed

Press **HS/STD/LS3/SP/LP** ( **////** ) to set the tape speed.

## Return to normal screen

Press **PROG.** or **OK**. "PROGRAM COMPLETED" appears on the screen for about 5 seconds, then normal screen appears.

## 8 Engage timer recording standby mode

Press **TIMER**.

The VCR turns off automatically and "Ⓢ" is displayed on the front display panel.

### To use the VCR while it is in timer recording standby mode

- Press **TIMER** to cancel the timer recording standby mode, then press **POWER** to turn on the VCR. DO NOT forget to put the VCR into timer recording standby mode again by pressing **TIMER** after you use the VCR; otherwise, you cannot record the broadcasts you want.
- When "AUTO TIMER" ( pg. 52) is set to "ON", the timer recording standby mode is automatically engaged when the VCR is turned off. It is temporarily canceled when the VCR is turned on. You do not have to press **TIMER** to engage or disengage the timer recording standby mode.

### IMPORTANT

If you have moved to a different area or if a broadcasting station's channel number has been changed, the wrong VCR CH or CABLE CH number will be displayed on the Program screen in step 5. When this happens, set the correct guide channel number for that station. ( pg. 36, "Changing VCR Plus+ Setting")

### NOTES:

- Even if a power failure occurs, the VCR keeps your timer programs. However, the clock time, channel settings, and other menu settings are lost if it lasts for more than 3 minutes. As a result, when the power is supplied again to this VCR after the power failure, the following will take place.
  1. This VCR starts the Plug & Play setting automatically to restore the clock time and channel setting.
  2. If the clock time and channel setting are restored correctly, each timer program you have made will start at its start time unless its end time has elapsed.
- To timer-record cable channels received through a cable box, be sure to keep the cable box turned on.

# Changing VCR Plus+® Setting

Turn on the VCR and the TV, and select the AV mode on the TV.

## IMPORTANT

If you have moved to a different area or if a broadcasting station's channel number has been changed, the wrong VCR CH or CABLE CH number will be displayed on the Program screen (→ step 5 on page 35). When this happens, perform the following steps to set the correct guide channel number for that station.

To ensure that VCR Plus+ timer recording operates correctly, it is necessary to set the VCR Plus+ "Guide Channel Set" for each station. Read the following information carefully.

## VCR Plus+ guide channel matching

The VCR Plus+ programming system assigns a VCR Plus+ guide channel to the TV channels and the cable channels. These guide channel numbers are also called the VCR Plus+ channel codes. Most TV listings have a section, usually a chart, indicating the guide channel numbers assigned to each station. For accurate VCR Plus+ programming, the VCR Plus+ guide channel number for each station should match the channel number on which it is received in your area.

## NOTES:

- In many instances, the VCR Plus+ guide channel numbers for cable and broadcast TV stations DO NOT match the channel number on which it is received by your VCR or cable box. Check your TV listing, or contact your cable supplier for details.
- Many TV stations can be viewed on cable. Check your TV listing, or contact your cable supplier for details.

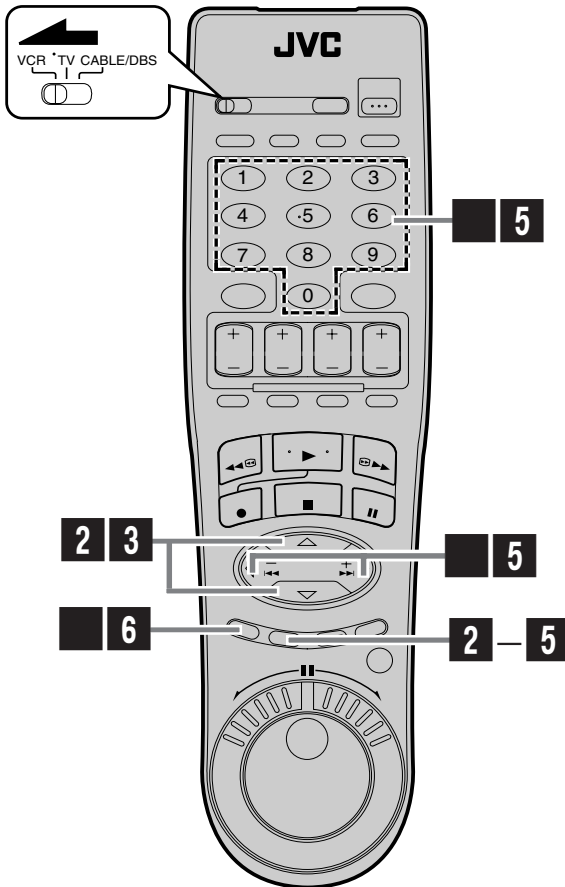



## Access Main Menu screen

Press **MENU**.

## 2 Access Tuner Set Up screen

Press  $\Delta\nabla$  to move the highlight bar (arrow) to "TUNER SET UP", then press **OK**.

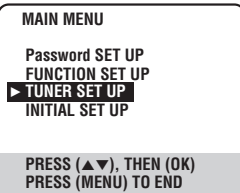

## 3 Access Guide Channel Set screen

Press  $\Delta\nabla$  to move the highlight bar (arrow) to "GUIDE CHANNEL SET", then press **OK**.

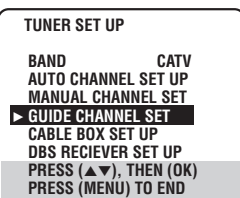

## Input guide channel number

Press the **Number** keys or  $\triangleleft$   $\triangleright$  to input the VCR Plus+ guide channel number as shown in the TV listing, then press **OK**.

(Ex.) When inputting the guide channel number 6 for WNJU(Ind.)

- If you receive your channels with a cable box and if you have properly set your Controller, "CABLE

CH" appears in place of "VCR CH". If not, refer to pages 15 – 17 and re-perform the procedure.

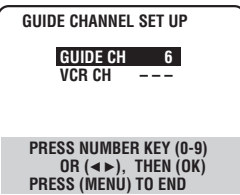

## 5 Input receiving channel number

Press the **Number** keys or  $\triangleleft$   $\triangleright$  to input the number of the channel on which the guide channel's broadcasts are received, then press **OK**.

(Ex.) If WNJU(Ind.) is received on channel 47

- Repeat steps **4** and **5** for each instance.

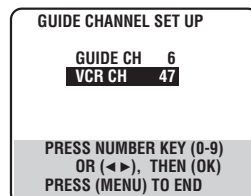

## 6 Return to normal screen

Press **MENU**.

# Express Timer Programming

Turn on the VCR and the TV, and select the AV mode on the TV.

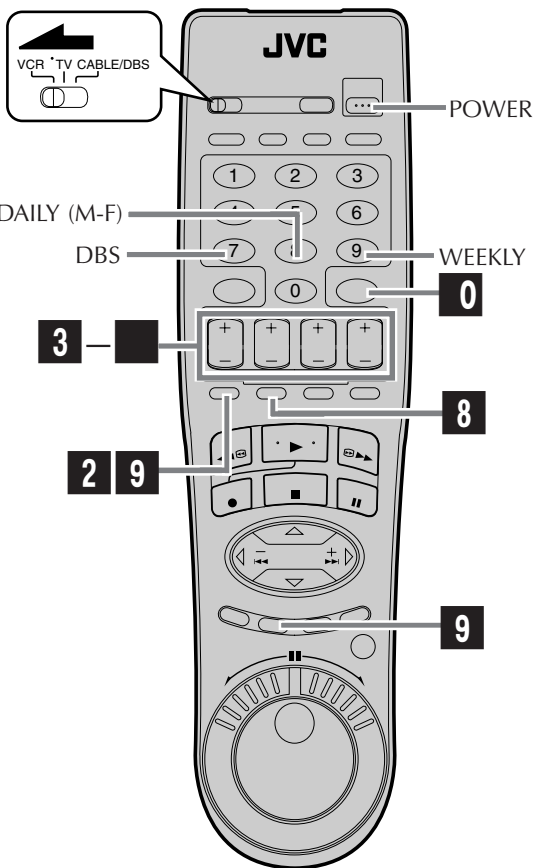
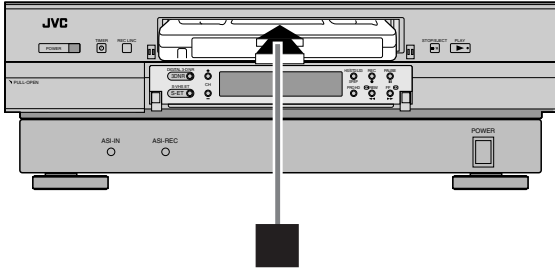

You can directly program the VCR's timer to record up to 24 broadcasts, as far as a year in advance. Remember, the clock must be set before you can program the timer (pg. 10).

## 1 Load a cassette

Make sure the record safety tab is intact. If not, cover the hole with adhesive tape, then load it into the VCR.

- The VCR turns on, and the counter is reset, automatically.

## 2 Access VCR PLUS+ screen

Press **PROG.**

## 3 Access Program screen

Press **START +/-** once.

PROGRAM		
START	STOP	DATE
--:--AM	--:--AM	--/--/--
CH		SUN
---		STD (SP)
PRESS (+/-, SP/EP, 8=DAILY 9=WEEKLY) THEN (OK) PRESS (PROG.) TO END		

## 4 Set program start time

Press **START +/-** repeatedly to enter the time you want recording to start.

- Press and hold **START +/-** to increase the time in 30-minute intervals.

PROGRAM		
START	STOP	DATE
8:00AM	--:--AM	--/--/--
CH		SUN
---		STD (SP)
PRESS (+/-, SP/EP, 8=DAILY 9=WEEKLY) THEN (OK) PRESS (PROG.) TO END		

## 5 Set program stop time

Press **STOP +/-** repeatedly to enter the time you want recording to stop.

- Press and hold **STOP +/-** to increase the time in 30-minute intervals.

## 6 Set program date

Press **DATE +/-**. (The current date is displayed on the screen. The date you enter appears in its place.)

## 7 Set channel number

Press **CH +/-**.

- If you are using a DBS receiver, see "ATTENTION FOR DBS RECEIVER USERS" on next page.
- Holding down **CH +/-** rapidly changes the channel numbers.

**8 Set tape speed**

Press **HS/STD/LS3/SP/LP** ( **///** ) to set the tape speed.

**9 Return to normal screen**

Press **PROG.** or **OK**.

"PROGRAM COMPLETED" appears on the screen for about 5 seconds, then normal screen appears.

**0 Engage timer recording standby mode**

Press **TIMER**.

The VCR turns off automatically and "Ⓞ" is displayed on the front display panel.

**To timer-record daily (Monday–Friday) or weekly serials**

Press **DAILY (M-F)** (number "8") or **WEEKLY** (number "9") anytime during steps **3** through **8**.

"DAILY" or "WEEKLY" appears on the Program screen.

- Pressing the button again makes the corresponding indication disappear.

**To use the VCR while it is in timer recording standby mode**

Press **TIMER** to cancel the timer recording standby mode, then press **POWER** to turn on the VCR.

DO NOT forget to put the VCR into timer recording standby mode again by pressing **TIMER** after you use the VCR; otherwise, you cannot record the broadcast you want.

- When "AUTO TIMER" (☞ pg. 52) is set to "ON", the timer recording standby mode is automatically engaged when the VCR is turned off. It is temporarily canceled when the VCR is turned on. You do not have to press **TIMER** to engage or disengage the timer recording standby mode.

**NOTES:**

- Even if a power failure occurs, the VCR keeps your timer programs. However, the clock time, channel settings, and other menu settings are lost if it lasts for more than 3 minutes. As a result, when the power is supplied again to this VCR after the power failure, the following will take place.
  1. This VCR starts the Plug & Play setting automatically to restore the clock time and channel setting.
  2. If the clock time and channel setting are restored correctly, each timer program you have made will start at its start time unless its end time has elapsed.
- Programs that start after midnight must have the next day's date.
- After timer recording is completed, the VCR turns off automatically.
- You can program the timer recording while a regular recording is in progress; the menu screens will not be recorded.
- If the tape reaches its end during timer recording, the cassette is automatically ejected.
- To timer-record cable or satellite channels, be sure to keep the cable box or DBS receiver turned on.

**ATTENTION FOR DBS RECEIVER USERS**

If you are using a DBS receiver (unless "DBS RECEIVER SET UP" is set to "OFF" ☞ pg. 19), the band indication (TV, CATV or DBS) appears under the channel number indication.

TV :To timer-record a regular TV broadcast received on the VCR.

CATV :To timer-record a cable TV broadcast received on the VCR, or through a cable box (unless "CABLE BOX SET UP" is set to "OFF" ☞ pg. 16).

DBS :To timer-record a satellite broadcast received through a DBS receiver.

PROGRAM		
START	STOP	DATE
8:00PM	10:00PM	12/24/03
CH		WED
DBS 110	STD (SP)	
PRESS (+/-, SP/EP, 8=DAILY 9=WEEKLY) THEN (OK) PRESS (PROG.) TO END		

**NOTE:**

If "BAND" is set to "TV" on the Tuner Set Up Screen (☞ pg. 14) and "CABLE BOX SET UP" is set to "OFF" on the Cable Box Set screen (☞ pg. 16), "CATV" will not be displayed on the Program screen; If "BAND" is set to "CATV" or "CABLE BOX SET UP" is set to "ON", "TV" will not be displayed.

If the channel number entered requires that the band be set, "7=DBS" is displayed on the screen. If this happens, press the **Number** key "7 (DBS)" to select "DBS".

Turn on the VCR and the TV, and select the AV mode on the TV.

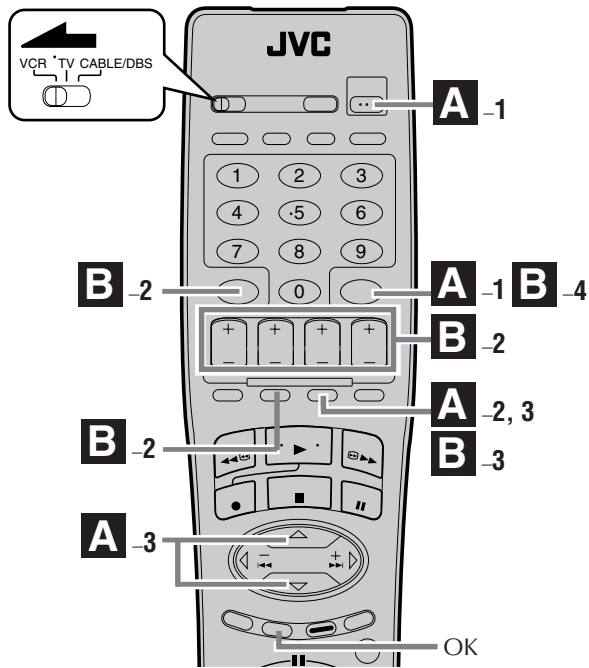

## B Canceling or changing program settings

### 1 Access Program screen

Repeat steps 1 to 3 in the left column.

### 2 Cancel or change program setting

To cancel a program, press CANCEL.

To change a program, press the appropriate button: START+/-, STOP+/-, DATE+/-, CH+/-, and/or HS/STD/LS3/SP/EP (///).

To return to the program List screen, press OK.

PROGRAM CHECK		
START	STOP	DATE
8:00PM	10:00PM	12/24/03
CH		WED
CATV 12	STD (SP)	

PRESS (CANCEL) TO CANCEL  
PRESS (OK) TO PROG. LIST  
PRESS (P. CHECK) TO END

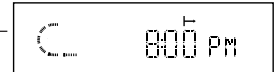

### 3 Return to normal screen

Press PROG. CHECK.

### 4 Reengage timer recording standby mode

Press TIMER.

When "AUTO TIMER" (pg. 52) is set to "ON", the timer recording standby mode automatically resumes when you turn off the VCR.

## A Checking program settings

### 1 Disengage timer

Press TIMER, then press POWER.

When "AUTO TIMER" (pg. 52) is set to "ON", you do not have to press TIMER.

### 2 Access Program List screen

Press PROG. CHECK.

PROGRAM LIST [2/3]				
DATE	START	STOP	CH	
▲ 12/24	8:00PM	10:00	12	
12/25	10:00AM	10:45	40	
12/25	11:30PM	1:00	125	
▶ 12/26	9:00PM	11:00	11	
12/27	11:00AM	11:45	39	
▼ 12/28	10:30PM	1:00	124	

SELECT WITH (▲▼) AND (OK)  
PRESS (P. CHECK) TO END

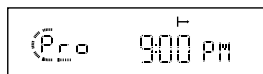

### 3 Access Program screen

Press Δ▽ to select a program, then press OK to check more detailed information.

Each time you press Δ▽, the program's information also appears on the front display panel.

See "Front display panel" in the right column.

To return to the normal screen, press PROG. CHECK.

### Front display panel

The indicators on the front display panel show the total number of timer-programs, the currently selected program (blinking).

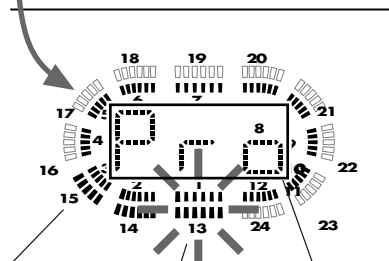
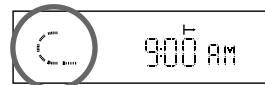

15 timer-recordings are already programmed.

13th program is currently selected.

"Pro" appears while timer-programming is made or Program List screen is displayed.

**ATTENTION**

If there is a conflict in the timer schedule and one program overlaps with another, only the parts shown below in gray will be recorded.

**Pattern 1:** *The program with the lower program number will be recorded.*

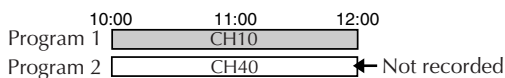

**Pattern 2:** *The program starting earlier will be recorded.*

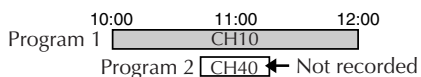

**Pattern 3:** *The program starting earlier will be recorded, followed by the remaining portion of the other program.*

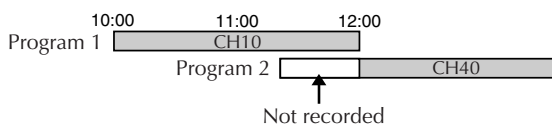
**Other Useful functions for timer recording**

You can also use the following functions for timer recording.

- **Auto Timer** (☞ pg. 52)

When "AUTO TIMER" is set to "ON", the timer recording standby mode is automatically engaged when the VCR is turned off. It is temporarily canceled when the VCR is turned on. You do not have to press **TIMER** to engage or disengage the timer recording standby mode.

- **Auto SP → EP Timer (S-VHS/VHS only)** (☞ pg. 52)

If there is not enough tape to record the entire broadcast for recording in SP mode, the VCR automatically switches to EP mode to allow complete recording. This feature is especially handy when recording a broadcast of more than 2 hours in length.

# PRO HD System Features

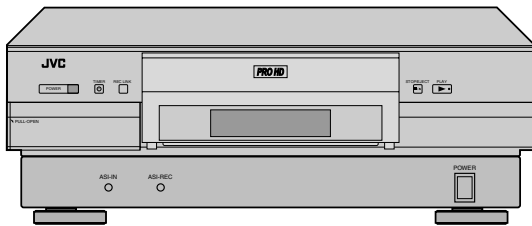

SR-VDA300U

- This digital video recorder is a professional deck designed for the PRO HD system.
- This system can record the MPEG2-TS signal on the D-VHS tape via the interface of DVB-ASI.
- This system is impossible to record by a D-VHS format.
- In the case of recording, the password can be set.



SR-VD400U

- Playback using SR-VD400U (optional) is possible by entering password, which is set for recording.

# Connection And Preparation

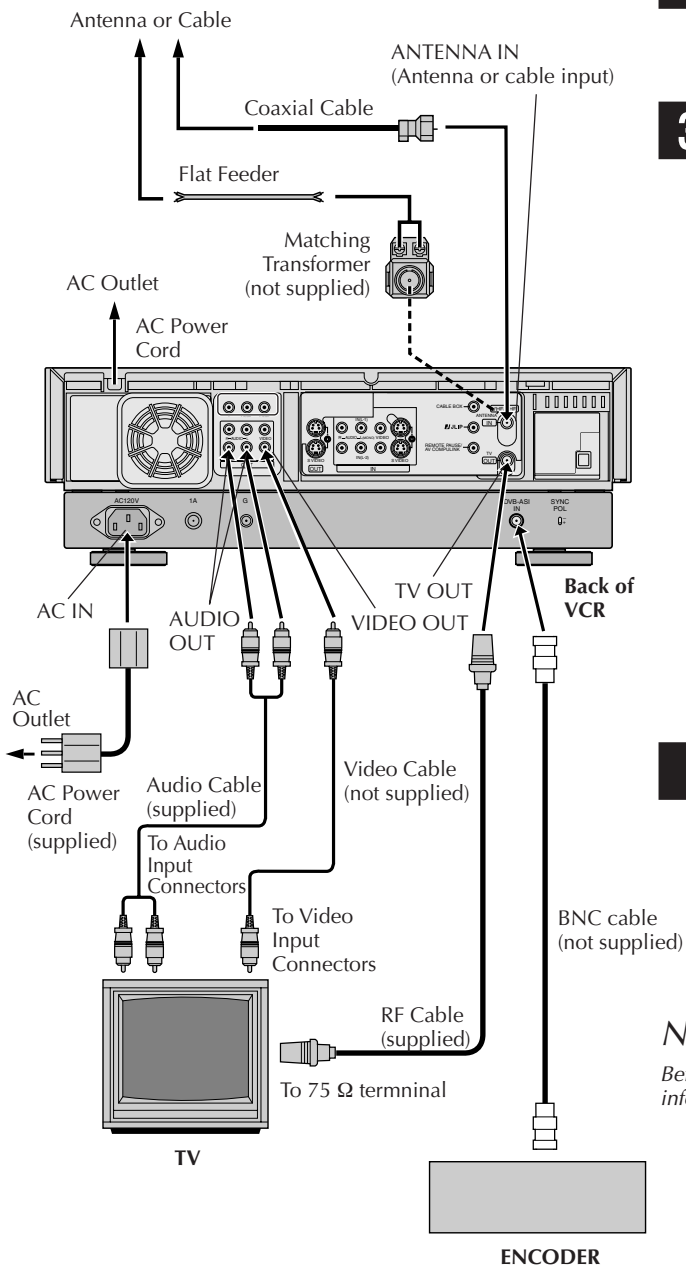

## Connection

### 1 Check contents

Make sure the package contains all of the accessories listed in "SPECIFICATIONS" (☞ pg. 75).

### 2 Situate VCR

Place the VCR on a stable, horizontal surface.

### 3 Connect VCR to TV

The following connections are required.

- 1 Disconnect the TV antenna from the TV.
- 2 Connect the TV antenna cable to the ANTENNA IN terminal on the rear of the VCR.
- 3 Connect the supplied RF cable between the TV OUT terminal on the rear of the VCR and the TV's antenna input terminal.
- 4 Connect an audio/video cable between the AUDIO/VIDEO OUT connectors on the rear of the VCR and the audio/video input connectors on the TV.
- 5 Connect the not supplied BNC cable between the DVB-ASI IN terminal on the rear of the VCR and the ENCODER's output terminal.

### Connect VCR to power source

Connect the supplied AC power cord to the AC In connector. Connect the AC power plug to the AC outlet.

- Please ensure connection of the supplied AC power cord.

### NOTE:

Before connection of the AC power cord, please read the safety information. (☞ pg.3)



## Preparations

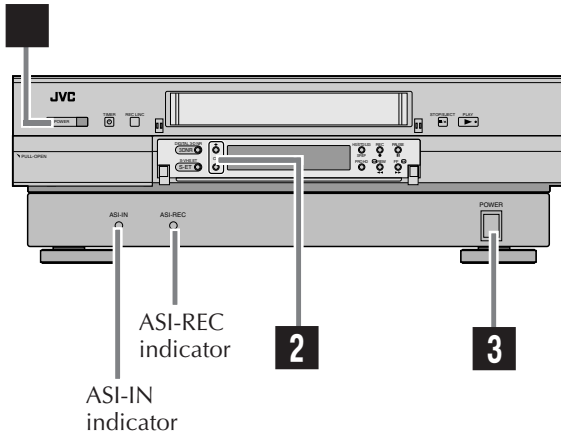

**1** Press **POWER** (upper left side)

**2** Select input location on this VCR

On the front panel or Remote :  
Press **CH +/-** to select an "I-" channel.

Proceed to the next step after 5 seconds.

**3** Press **POWER** (lower right side)

ASI-REC indicator will light. (It may take a few seconds for it to light.)  
If a signal is input to an DVB ASI IN connector, ASI-IN indicator lights.

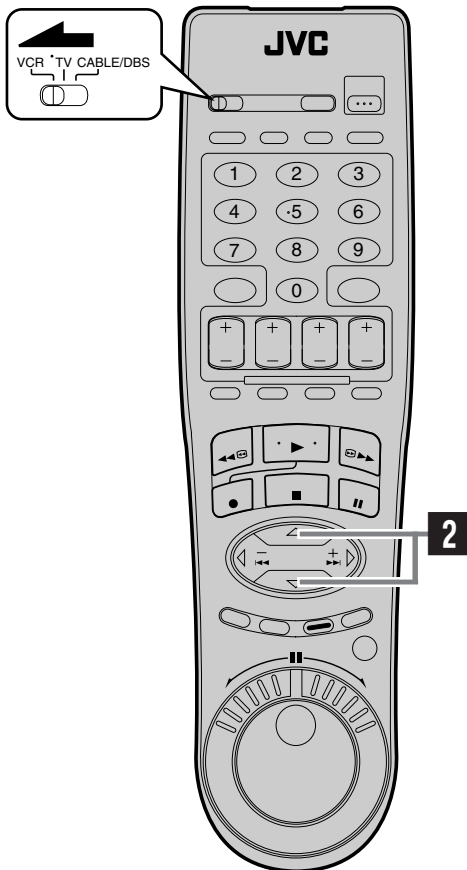

### NOTE:

ASI signals will not be recorded if above procedures are not followed.

# Recording

Turn on the VCR and the TV, and select the AV mode on the TV.

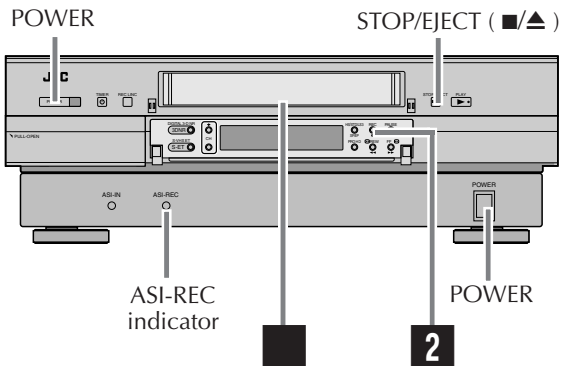

This VCR can check the tape condition during recording (and playback), and realizes the best possible pictures.

In the case of recording, the password can be set. When you set up a password, please carry out before recording. Please refer to next page for the procedure of setting the password.

## Load a D-VHS cassette

Make sure the record safety tab is intact. If not, cover the hole with adhesive tape before inserting the cassette.

- The D-VHS indicator lights on the front display panel and the PRO HD recording mode is selected automatically.

## 2 Start recording

### On the front panel:

Press **REC** (●).

### On the Remote:

While holding **REC** (●), press **PLAY** (▶).

- The ASI-REC indicator light changes to orange.
- Recording speed is AUTO mode.  
 AUTO mode: The recording speed will be selected automatically according to the amount of data input.

## To stop playback

Press **STOP** (■) on the Remote or **STOP/EJECT** (■/▲) on the front panel.

## To rewind the tape (when it is not running)

Press **REW** (◀◀).

## To fast-forward (when it is not running)

Press **FF** (▶▶).

## To eject the tape

Press **STOP/EJECT** (■/▲) on the front panel when the tape is not running.

- You can also eject the cassette when the VCR is turned off.

## To turn off the VCR

Press **POWER**.

### To record in S-VHS mode on D-VHS tapes:

Press **PRO HD** to turn off the D-VHS indicator. Then, set "S-VHS MODE" to "ON" (☞ pg. 53).

### To record in VHS mode on D-VHS tapes:

Press **PRO HD** to turn off the D-VHS indicator. Then, set "S-VHS MODE" to "OFF" (☞ pg. 53).

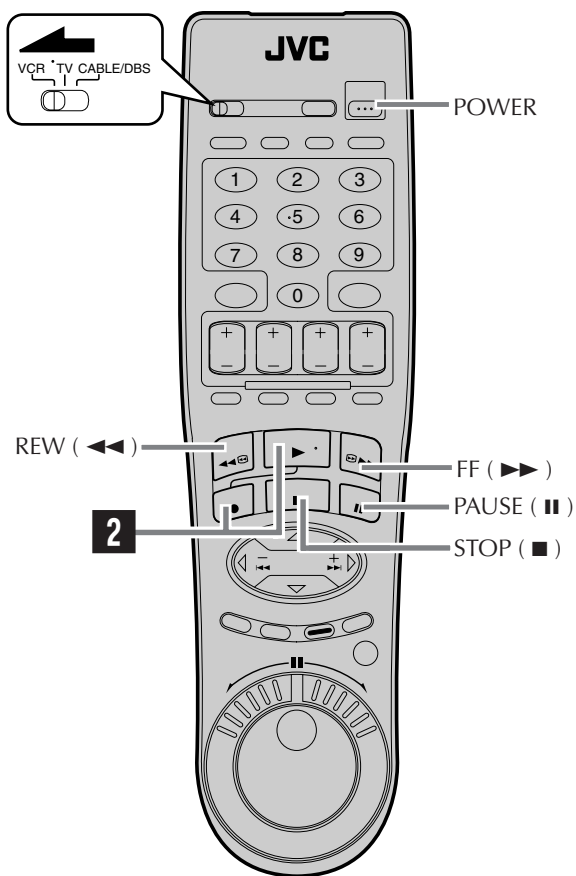

# Password SET UP

Turn on the VCR and the TV, and select the AV mode on the TV.

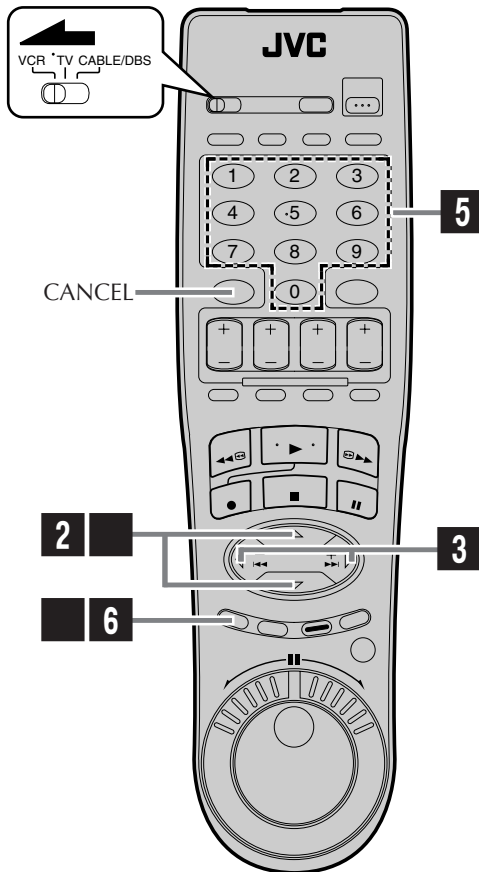

You can use the password setting function on the Password Set Up screen by following the procedure described below.

## 1 Access Main Menu screen

Press **MENU**.

## 2 Access Password Set Up screen

Press  $\Delta$ / $\nabla$  to move the highlight bar (arrow) to "Password SET UP" then press **OK**.

```

MAIN MENU
▶ Password SET UP
  FUNCTION SET UP
  TUNER SET UP
  INITIAL SET UP

PRESS (▲▼), THEN (OK)
PRESS (MENU) TO END
  
```

## 3 Select Password Enabled

Press  $\leftarrow$ / $\rightarrow$  to move the highlight bar (arrow) to "Password Enabled".

- If "Password Disabled" is selected, the password is not required at the time of playback by other model (SR-VD400U).

```

Password SET UP
▶ Password Enabled
  Lock number [ 0 ]
                (0-65534)
  [P]

PRESS (◀▶), TO SET
PRESS (MENU) TO END
  
```

## 4 Select Lock number

Press  $\Delta$ / $\nabla$  to move the highlight bar (arrow) to "Lock number".

```

Password SET UP
  Password Enabled
▶ Lock number [ 0 ]
                (0-65534)
  [P]

PRESS (▲▼), TO SET
PRESS (MENU) TO END
  
```

## 5 Input Lock number

Press the 5-digit **Number** keys to input the Lock number.

- To make correction, press **CANCEL** and input the Lock number.

```

Password SET UP
  Password Enabled
▶ Lock number [ 12345 ]
                (0-65534)
  [P]

PRESS (◀▶), TO SET
PRESS (MENU) TO END
  
```

## 6 Return to normal screen

Press **MENU**.

### NOTES:

- The item with displaying the "P" is only for serviceman uses.
- Set and store only 1 password for every tape as a tape does not support a multiple number of passwords.

# Playback

Turn on the VCR and the TV, and select the AV mode on the TV.

This VCR can check the tape condition during playback (and recording), and realizes the best possible pictures.

## Load a D-VHS cassette

Make sure the window side is up, the rear label side is facing you and the arrow on the front of the cassette is pointing towards the VCR.

Do not apply too much pressure when inserting.

- The VCR turns on automatically.
- The counter is automatically reset to "0:00:00".
- The tape will run for a few seconds while the VCR searches for the tape number. If the tape number is found, it will be shown on the TV screen if "SUPERIMPOSE" is set to "ON" (pg. 52).
- If the cassette's record safety tab has been removed, playback begins automatically.

## 2 Start playback

Press **PLAY** (▶).

- Tape speed is automatically detected.

## To stop playback

Press **STOP** (■) on the Remote or **STOP/EJECT** (■/▲) on the front panel.

## To rewind the tape (when it is not running)

Press **REW** (◀◀).

## To fast-forward (when it is not running)

Press **FF** (▶▶).

## To eject the tape

Press **STOP/EJECT** (■/▲) on the front panel when the tape is not running.

- You can also eject the cassette when the VCR is turned off.

## To turn off the VCR

Press **POWER**.

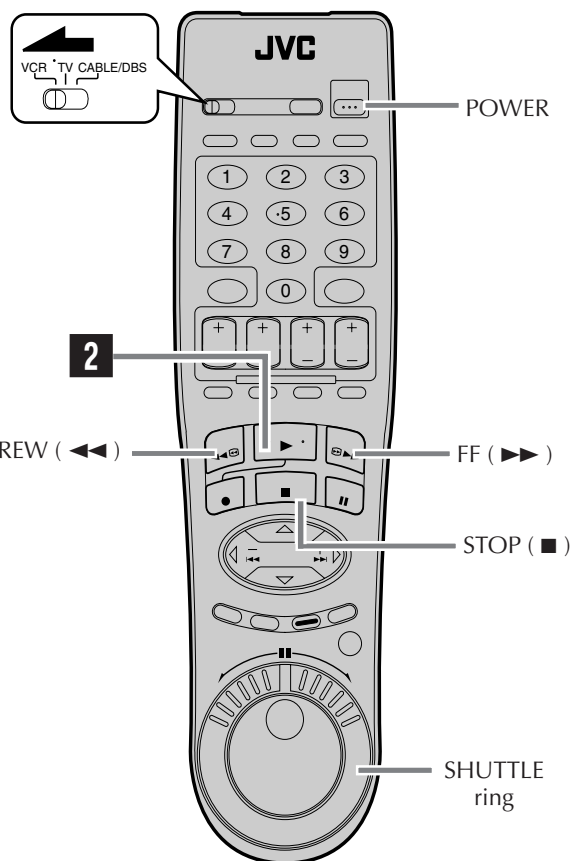
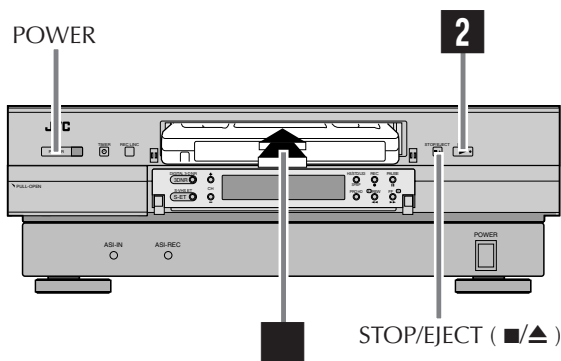

## NOTE:

When playing back a tape recorded in PRO HD format, the **JOG** dial and **SHUTTLE** ring do not work.

# Useful Function Settings

Turn on the VCR and the TV, and select the AV mode on the TV.

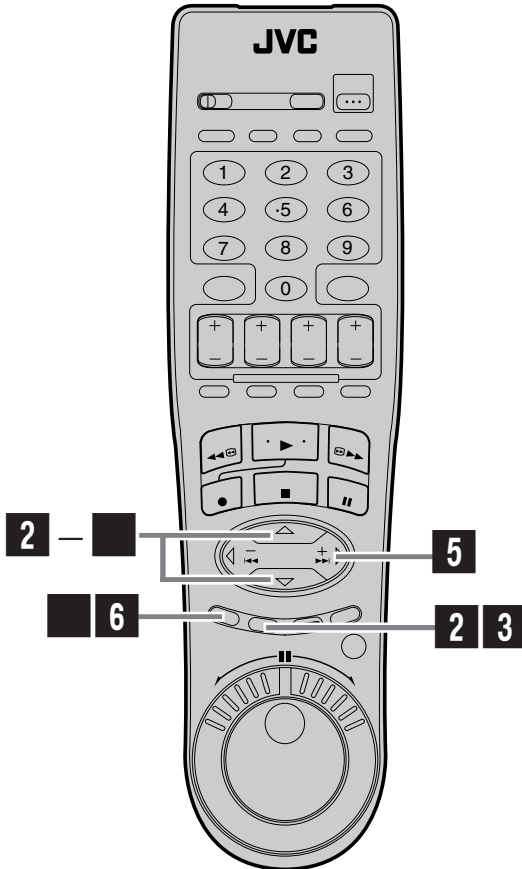

You can use the other useful function settings on the Function Set Up screens by following the procedure described below.

- For the functions you can set on the Function Set Up screen, see pages 49 to 53.

## Access Main Menu screen

Press **MENU**.

## 2 Access Function Set Up screen

Press  $\Delta\nabla$  to move the highlight bar (arrow) to "FUNCTION SET UP", then press **OK**.

MAIN MENU

Password SET UP  
**▶ FUNCTION SET UP**  
 TUNER SET UP  
 INITIAL SET UP

PRESS ( $\Delta\nabla$ ), THEN (OK)  
 PRESS (MENU) TO END

## 3 Select Function Menu.

Press  $\Delta\nabla$  to move the highlight bar (arrow) to the menu of the function you want to set, then press **OK**.

FUNCTION SET UP

**▶ VIDEO FUNCTION**  
 AUDIO FUNCTION  
 IN/OUT FUNCTION  
 ADDITIONAL

PRESS ( $\Delta\nabla$ ), THEN (OK)  
 PRESS (MENU) TO END

## Select Function.

Press  $\Delta\nabla$  to move the highlight bar (arrow) to the function you want to set.

FUNCTION SET/VIDEO (VHS)

**▶ V. CALIBRATION** ON  
 PICTURE CONTROL AUTO  
 DIGITAL R3 ON  
 VIDEO STABILIZER OFF

SELECT WITH ( $\Delta\nabla$ ) AND ( $\triangleleft$ )  
 PRESS (MENU) TO END

## 5 Change setting

Press  $\triangleleft$   $\triangleright$ .

## 6 Return to normal screen

Press **MENU**.

### NOTE:

To go back to a previous screen during settings, press **BACK** ( $\triangleleft$ ).

## Video settings [VIDEO (VHS)]

\* The default setting is **bold** in the table below.

<p>■ <b>V, CALIBRATION</b> (S-VHS/VHS only) <b>ON</b> OFF</p>	<p>When this function is set to "ON", this VCR checks the condition of the tape in use during playback and recording, and compensates to provide the highest-possible pictures. This takes place whenever you play back a tape or start recording after inserting a tape.</p> <p><b>NOTES:</b></p> <ul style="list-style-type: none"> <li>• During playback, this function is always working even though "V, CALIBRATION" appears just at the beginning of automatic tracking.</li> <li>• During recording, this function works only for the first EP recording and the first SP recording on an inserted tape. For timer recording, this function checks the tape condition both for the SP recording and the EP recording before the first timer recording starts.</li> <li>• When you play back rental tapes or tapes recorded on other VCRs, set this function either "ON" or "OFF" whichever gives you the best picture.</li> </ul>
<p>■ <b>PICTURE CONTROL</b> (S-VHS/VHS only) <b>AUTO (NORM)</b> EDIT SOFT SHARP</p>	<p>This function helps you to adjust the playback picture quality according to your preference.</p> <p><b>AUTO:</b> Normally select this. Picture quality is adjusted (NORM) automatically. When "V, CALIBRATION" is "OFF", "NORM" will appear instead of "AUTO".</p> <p><b>EDIT:</b> Minimizes picture degradation during editing (recording and playback).</p> <p><b>SOFT:</b> Reduces image coarseness when viewing overlaid tapes containing much noise.</p> <p><b>SHARP:</b> Clearer, sharper-edged picture when viewing images with much flat, same-colored surfaces such as cartoons.</p> <p><b>NOTES:</b></p> <ul style="list-style-type: none"> <li>• When you select "EDIT", "SOFT" or "SHARP", the selected mode will not change until you select again.</li> <li>• Select "EDIT" when you are editing tapes (☞ pg. 56 – 58). After you finish editing the tapes, select "AUTO" ("NORM" when "V, CALIBRATION" is "OFF".)</li> </ul>
<p>■ <b>DIGITAL R3 (S-VHS/VHS only)</b> <b>ON</b> OFF</p>	<p>When this function is set to "ON", edge correction to the luminance signal is performed to enhance details. Normally set this function to "ON".</p> <p><b>NOTES:</b></p> <ul style="list-style-type: none"> <li>• Depending on the type of tape being used, picture quality may be better with "DIGITAL R3" set to "OFF".</li> <li>• If you use this VCR as the playback VCR for editing, be sure to set "DIGITAL R3" to "OFF" before starting.</li> </ul>
<p>■ <b>VIDEO STABILIZER</b> (S-VHS/VHS only) <b>ON</b> OFF</p>	<p>When this function is set to "ON", you can automatically correct vertical vibrations in the picture when playing back unstable recordings made on another VCR.</p> <p><b>NOTES:</b></p> <ul style="list-style-type: none"> <li>• When you finish viewing a tape, be sure to set this function to "OFF".</li> <li>• Regardless of the setting, this function has no effect during recording and during special effects playback.</li> <li>• The on-screen display may jitter vertically when this function is set to "ON".</li> <li>• To watch recordings with close-caption, set this function to "OFF".</li> </ul>

CONTINUED ON NEXT PAGE →

## Audio settings [AUDIO]

\* The default setting is **bold** in the table below.

### ■ OPTICAL OUT Dolby D 2CH-PCM

This VCR can send the Dolby Digital bitstream or PCM Audio to external devices.

When you play back a tape including the Dolby Digital bitstream, and if you have a device equipped with Dolby Digital decoder, set this function to "Dolby D".

If not, set this function to "2CH-PCM".

The digital audio is output only when you play back a tape recorded in D-VHS format. The digital audio is not output when you play back a tape recorded in S-VHS/VHS format.

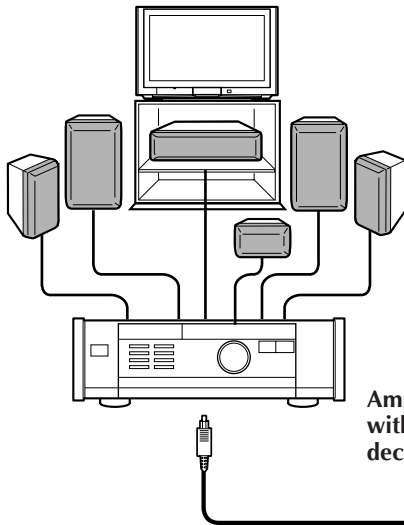

Amplifier equipped  
with Dolby Digital  
decoder

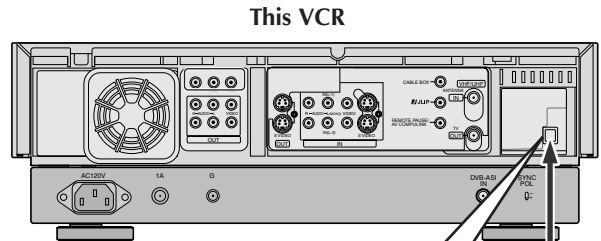

This VCR

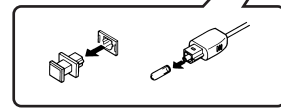

**Note for connection:**  
Remove the connector cover  
from the VCR and the  
protection cap from the cable.

### ■ 2ND AUDIO REC ON OFF

**When this function is set to "ON";**

- If a SAP program is received, the SAP audio is recorded on both the normal and Hi-Fi tracks. The main audio is not recorded.
- If a non-SAP program is received, the main audio is recorded on both the Hi-Fi and normal tracks.

**When this function is set to "OFF", the SAP audio cannot be recorded.**



## Input/Output settings [IN/OUT]

\* The default setting is **bold** in the table below.

<p>■ <b>TV OUTPUT 1</b>  <b>720to1080</b>          NO CONV.          ALLto480i</p>	<p>Select the appropriate mode when playing back a D-VHS tape containing a recording of an HD (High Definition) signal:</p> <p><b>720to1080:</b> 720p is up-converted to 1080i and output to the TV. 1080i, 480p, and 480i image formats are output to the TV without being converted. Select this when the 720p image played back is distorted.</p> <p>NO CONV.: 1080i, 720p, 480p, and 480i image formats are output to the TV just as they are.</p> <p>ALLto480i: All images will be output to the TV in 480i image format.</p> <p><b>NOTE:</b>  <i>When you play back the picture of 1080i, 720p, 480p image format, the signal is not output from the S-VIDEO or VIDEO output connector.</i></p>
<p>■ <b>TV OUTPUT 2</b>  <b>WIDE16:9</b>          NORM4:3</p>	<p>Select the appropriate mode depending on the type of TV you have.</p> <p><b>WIDE16:9:</b> Select this for a wide TV set with 16:9 screen image size.  <b>NORM4:3:</b> Select this for a TV set with 4:3 screen image size.</p> <p><b>NOTES:</b></p> <ul style="list-style-type: none"> <li>• When "TV OUTPUT 2" is set to "WIDE16:9", sometimes the screen image may be stretched vertically.</li> <li>• When "TV OUTPUT 2" is set to "NORM4:3", sometimes subtitles may not be visible or the ends of the screen image may be cut off. Normally select "WIDE16:9".</li> <li>• In order to let the equipment determine the screen image size, it is recommended that you connect the VCR and TV using the component video output connectors or S VIDEO OUT connector.</li> </ul> <p><b>ATTENTION:</b>  <i>When recording by down-conversion, the screen image will be stretched vertically regardless of "TV OUTPUT 2" setting.</i></p>
<p>■ <b>FRONT AUX F-1</b>  <b>VIDEO</b>          S-VIDEO</p>	<p>You have to select which terminal — either VIDEO (composite) or S-VIDEO (Y/C separate signals) to use as the video input terminal on the front panel.</p> <p>Make sure to select the correct terminal; otherwise, you may fail in recording (editing) on this VCR.</p>
<p>■ <b>REAR AUX L-1</b>  <b>VIDEO</b>          S-VIDEO</p>	<p>You have to select which terminal — either VIDEO (composite) or S VIDEO (Y/C separate signals) to use as the video input terminal (L-1) on the rear panel.</p> <p>Make sure you select the correct terminal; otherwise, you may fail in recording (editing) on this VCR.</p>
<p>■ <b>REAR AUX L-2</b>  <b>VIDEO</b>          S-VIDEO</p>	<p>You have to select which terminal — either VIDEO (composite) or S VIDEO (Y/C separate signals) to use as the video input terminal (L-2) on the rear panel.</p> <p>Make sure you select the correct terminal; otherwise, you may fail in recording (editing) on this VCR.</p>

CONTINUED ON NEXT PAGE →

## Additional settings [ADDTL]

\* The default setting is **bold** in the table below.

<p>■ <b>AUTO SP → EP TIMER</b> (S-VHS/VHS only) ON OFF</p>	<p>When this function is set to "ON", the VCR automatically switches to EP mode to allow complete recording if there is not enough tape to record the entire program while timer-recording in SP mode.</p> <p><b>For Example . . .</b> Recording a program of 140 minutes in length onto a 120-minute tape</p> <table border="1" style="margin-left: auto; margin-right: auto;"> <tr> <td style="text-align: center;">Approximately 110 minutes</td> <td style="text-align: center;">Approximately 30 minutes</td> </tr> <tr> <td style="text-align: center;">SP mode</td> <td style="text-align: center;">EP mode</td> </tr> </table> <p>Make sure you set this function to "ON" before the timer-recording starts.</p> <p><b>NOTES:</b></p> <ul style="list-style-type: none"> <li>● If you have programmed the VCR to timer-record 2 or more programs, the second program and those thereafter may not fit on the tape with this function set to "ON". In this case, do not use this function, but change the tape speed manually during timer programming.</li> <li>● In order to ensure that the recording fits on the tape, this function may leave a slight non-recorded portion at the end of the tape.</li> <li>● There may be some noise and sound disturbance where the tape speed switches from SP to EP mode on the tape.</li> <li>● This function is not available during ITR (Instant Timer Recording), and will not work properly on the following tapes: T(ST)-30, T(ST)-60, T(ST)-90, and T(ST)-120.</li> </ul>	Approximately 110 minutes	Approximately 30 minutes	SP mode	EP mode
Approximately 110 minutes	Approximately 30 minutes				
SP mode	EP mode				
<p>■ <b>AUTO TIMER</b> ON OFF</p>	<ul style="list-style-type: none"> <li>● <b>When this function is set to "ON":</b> The timer recording standby mode is automatically engaged when the VCR is turned off. It is temporarily canceled when the VCR is turned on. You do not have to press <b>TIMER</b> to engage or disengage the timer recording standby mode.</li> <li>● <b>When this function is set to "OFF":</b> You have to press <b>TIMER</b> to engage or disengage the timer recording standby mode.</li> </ul>				
<p>■ <b>SUPERIMPOSE</b> ON OFF</p>	<p>When this function is set to "ON", various VCR status information (on-screen display) appears on the screen.</p> <p><b>NOTES:</b></p> <ul style="list-style-type: none"> <li>● When you use this VCR as the playback VCR for editing a tape, be sure to set this function to "OFF"; otherwise, the VCR status information (on-screen display) will be recorded on the edited tape.</li> <li>● If you select a channel on which no signal is received, the channel number is displayed regardless of this function setting.</li> </ul>				
<p>■ <b>GRAY BACK</b> ON OFF</p>	<p>When this function is set to "ON", the VCR changes the screen into the gray back screen automatically after/while the input signals do not come into.</p>				
<p>■ <b>POWER SAVE MODE</b> ON OFF</p>	<p>When this function is set to "ON", you can reduce the power consumption. While the VCR is turned off, the front display panel does not show the clock.</p> <p>When this function is set to "OFF", an i.LINK device cannot be recognized. As a result, it is not possible to record a program using the digital tuner's* timer function. In addition the device does not pass along data if it is in a branched connection.</p> <p>* A digital tuner will be released in the future.</p>				
<p>■ <b>FRONT DISPLAY</b> <b>TAPE RUN</b> A. LEVEL OFF</p>	<p>You can switch the guide track indicator on the front display panel as follows (☞ pg. 74):</p> <p><b>TAPE RUN:</b> displays the remaining time (inside) and the tape position (outside).</p> <p><b>A. LEVEL:</b> displays the audio level (inside for right sound/outside for left sound).</p> <p><b>OFF:</b> turns display off.</p>				

\* The default setting is **bold** in the table below.

<p>■ <b>S-VHS MODE</b> ON OFF</p>	<p>You can determine which recording mode — either S-VHS mode or VHS mode — is used for recording on D-VHS and S-VHS tapes.</p> <p><b>When this function is set to “ON”</b>, you can record on D-VHS and S-VHS tapes with S-VHS picture quality.</p> <p><b>When this function is set to “OFF”</b>, you can record on D-VHS and S-VHS tapes with VHS picture quality.</p> <p><b>NOTES:</b></p> <ul style="list-style-type: none"> <li>● To record in S-VHS/VHS mode on D-VHS tape, press <b>PRO HD</b> to turn off the D-VHS indicator.</li> <li>● S-VHS mode allows you to make high quality video recordings with horizontal resolution of 400 lines, comparing with the 230 lines of resolution of conventional VHS recordings. To achieve the highest quality picture we recommend to record in S-VHS mode. (But remember that a conventional VHS VCR without SQPB cannot play back S-VHS tapes recorded in S-VHS mode.)</li> <li>● S-VHS MODE setting does not affect recording on VHS tapes. Recording on VHS tapes is always performed in VHS mode except when using S-VHS ET mode (☞ pg. 29).</li> </ul>
<p>■ <b>AV COMPU-LINK</b> ON OFF</p>	<p>The REMOTE PAUSE/AV COMPULINK terminal on the rear panel can be used as either the REMOTE PAUSE terminal or the AV COMPULINK terminal.</p> <p><b>When this function is set to “ON”</b>, you can use this terminal as the AV COMPULINK terminal.</p> <p>By connecting other JVC’s AV COMPULINK components (see the diagram below), including amplifiers (or receivers) and televisions, one touch control of the audio and video components linked via their AV COMPULINK connectors becomes possible.</p> <p><b>For example:</b> simply load a cassette in the VCR and press <b>PLAY (▶)</b> so that the AV COMPULINK components automatically turn on, the TV’s AV mode is selected and the VCR starts playback. (You do not have to press <b>PLAY (▶)</b> if the cassette’s record safety tab is removed.)</p> <p><b>When this function is set to “OFF”</b>, you can use this terminal as the REMOTE PAUSE terminal. (☞ pg. 56)</p> <p><b>NOTE:</b> Connection varies depending on the type of JVC TV you have. Refer to the TV’s instruction manual when making this connection.</p>

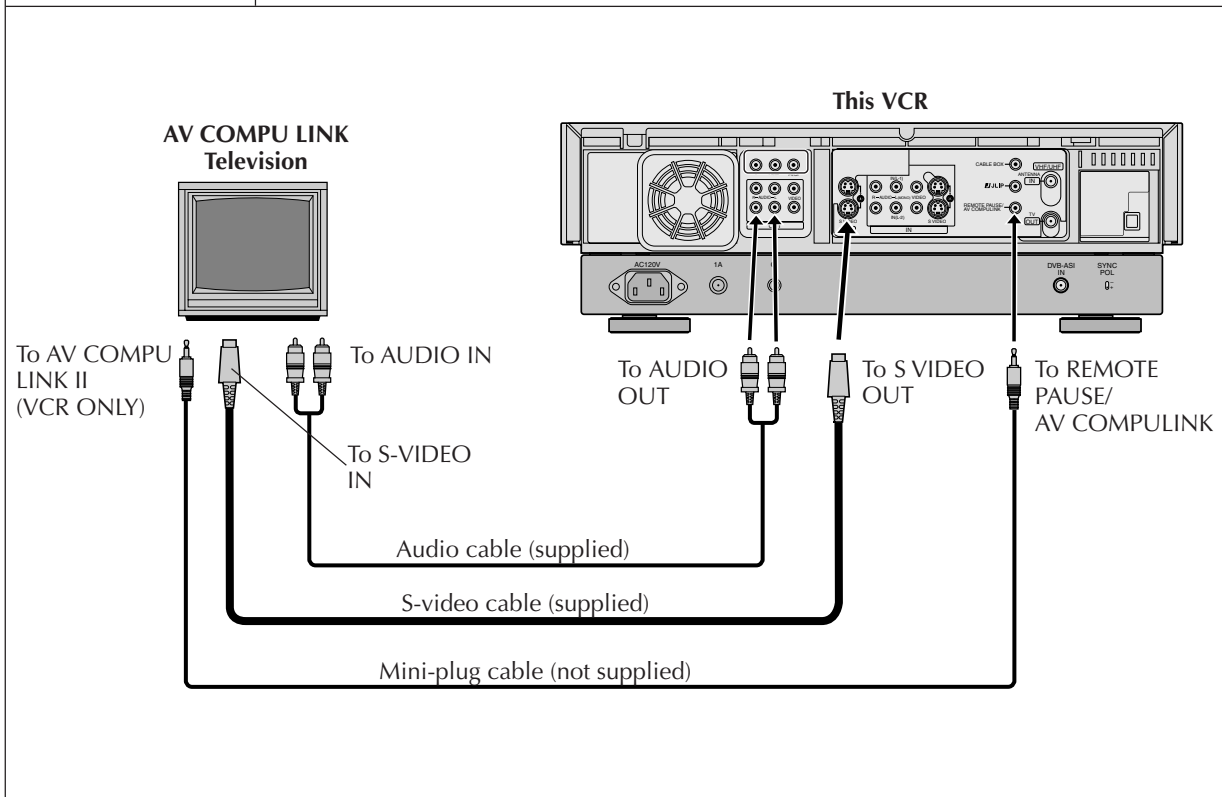

# Satellite Auto Recording

This function allows you to automatically record a satellite program which is timer-programed on your DBS receiver.

**Preparation:** Connect a DBS receiver to the AUDIO/VIDEO IN or S VIDEO IN (L-1) connectors\* on the rear; otherwise, you cannot use this function.

• You can also connect the cable box if it has a timer.

\* To use these connectors, you have to select which one to use (☞ pg. 51).

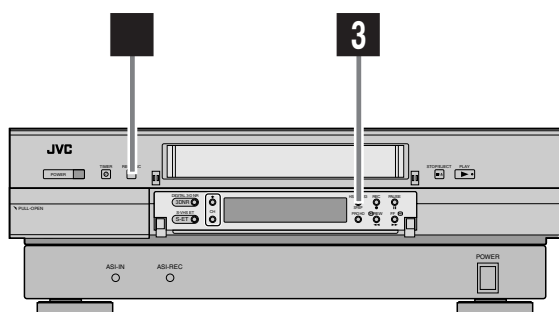

## Set timer program on DBS receiver

- For timer programing method, refer to the manual supplied with the DBS receiver.

## 2 Load a cassette

Make sure the record safety tab is intact.

## 3 Set tape speed

Press **HS/STD/LS3/SP/EP** ( **L-1** ) to set the recording speed.

## Engage Satellite Auto Recording standby mode

Press and hold **REC LINK** for more than 2 seconds.

The VCR turns off automatically and the “L-1” appears on the front display panel (Satellite Auto Recording standby mode).

When signals come into the VCR from the DBS receiver, the VCR starts recording (“L-1” blinks and the record ( ) indicator lights), and stops recording and goes off when signals stop coming in.

- Each time you press the button, Satellite Auto Recording standby mode turns on and off. When it is off, “L-1” disappears.

**IMPORTANT:** Be sure not to turn on the DBS receiver before the program starts broadcasting; otherwise, the VCR will start recording when the DBS receiver is turned on.

## NOTES:

- While the Satellite Auto Recording standby mode or after Satellite Auto Recording is finished, the VCR will not enter the timer recording standby mode even though “AUTO TIMER” is set to “ON”. (☞ pg. 52)
- If you turn off this VCR while Satellite Auto Recording is in progress, recording stops.
- Video Calibration (☞ pg. 49) does not work while Satellite Auto Recording is in progress.
- Auto Clock (☞ pg. 11) does not work while in the Satellite Auto Recording standby mode.
- The VCR may not record a short portion at the beginning of the program or may record slightly longer than the actual length of the program when Satellite Auto Recording method is used.
- If you engage the Satellite Auto Recording standby mode while the DBS receiver is turned on, the VCR will not start Satellite Auto Recording, and “Err L-1” appears on the front display panel. When you turn off the DBS receiver, “L-1” appears instead of “Err L-1” and the VCR enters the Satellite Auto Recording standby mode.
- If you have connected another component other than a DBS receiver (or cable box) to the AUDIO/VIDEO IN or S VIDEO IN (L-1) connectors, be sure not to engage the Satellite Auto Recording standby mode; otherwise, the VCR will start recording when the connected component is turned on.
- Satellite Auto Recording and timer-recording cannot be performed at the same time.
- If the “L-1” blinks quickly on the front display panel in the Satellite Auto Recording standby mode (even though your DBS receiver is turned off), Satellite Auto Recording will not work properly. If this is the case, perform “Express Timer Programing” (☞ pg. 38) to timer-record a satellite program. (Some DBS receivers output signals even if the power is off. Satellite Auto Recording is not possible with those DBS receivers.)

# JLIP ID Number Setting

The JLIP (Joint Level Interface Protocol) terminal is used to connect the VCR to a personal computer or similar device. By connecting through the JLIP terminals, you can control the VCR during editing and certain other operations, from the connected personal computer or similar device.

When connecting this VCR to another device using the JLIP terminals, each device must have a different JLIP ID number.

The JLIP ID number of this VCR is preset to "1" when shipped from the factory. You can change this number to any other number between 1 to 99.

**To change the JLIP ID number of this VCR,** follow the procedure below.

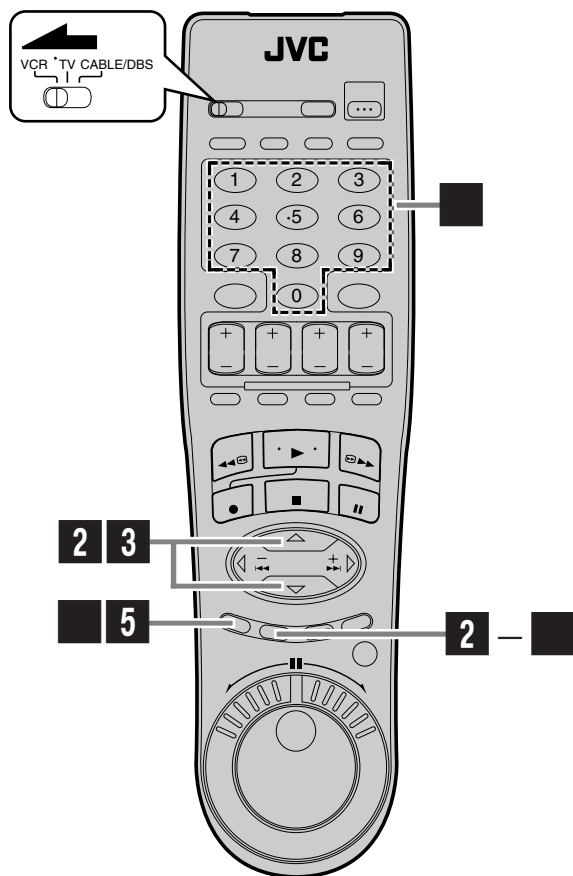

## 1 Access Main Menu screen

Press **MENU**.

## 2 Access Initial Set Up screen

Press  $\Delta\nabla$  to move the highlight bar (arrow) to "INITIAL SET UP", then press **OK**.

## 3 Select JLIP ID Set Up screen

Press  $\Delta\nabla$  to move the highlight bar (arrow) to "JLIP ID SET UP", then press **OK**.

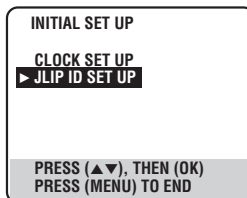

## 4 Set JLIP ID Number

Press the **Number** keys to enter the desired ID number, then press **OK**.

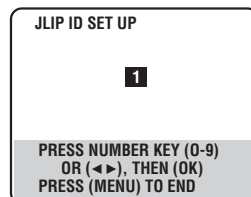

## 5 Return to normal screen

Press **MENU**.

### NOTE:

For further details on the JLIP system or devices, consult your nearest JVC dealer.

U.S. customers can contact JVC directly toll free at 1-800-252-5722.

# Edit From Camcorder

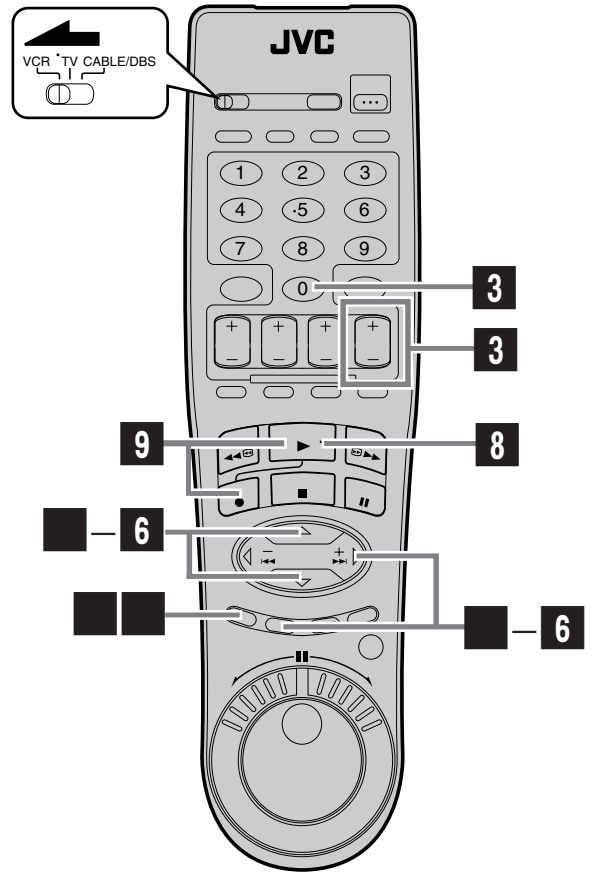
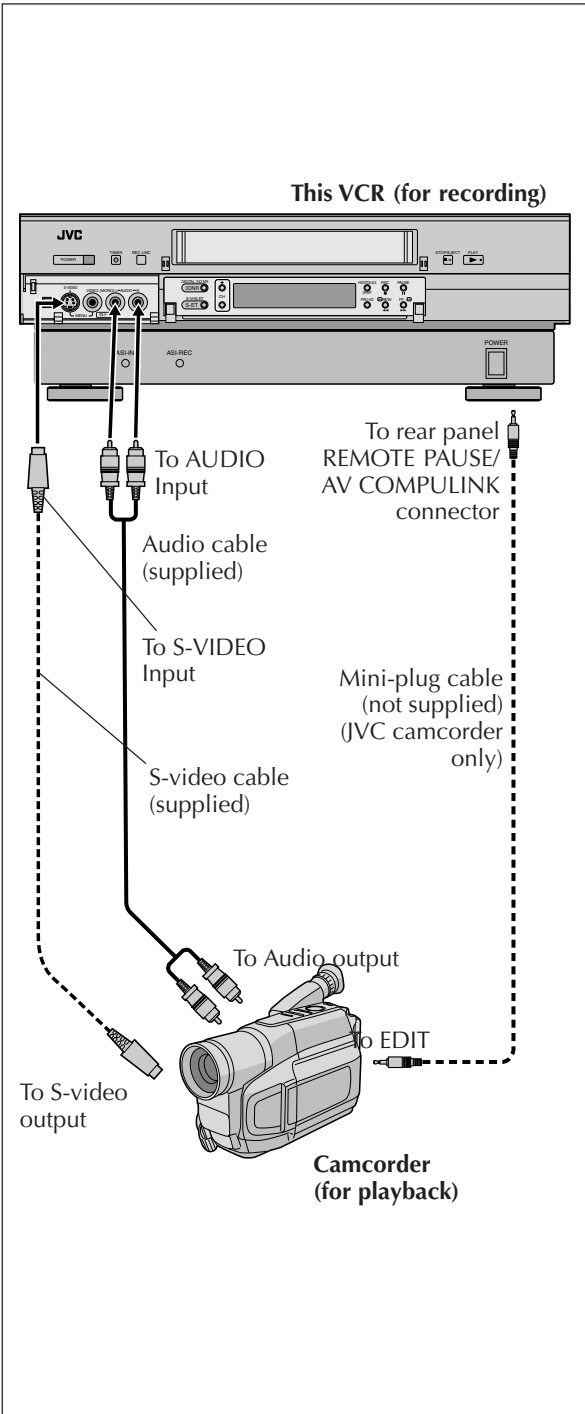

### Various connection for editing tapes

The following three methods can be used for editing tapes.

- **VHS to S-VHS editing (VIDEO-VIDEO connection):**  
Although the picture quality is inherently limited by the original VHS quality, the edited tape has better picture quality than those made by VHS-to-VHS editing.
- **S-VHS to VHS editing (VIDEO-VIDEO connection):**  
Since the original source is recorded in S-VHS mode, the edited tape has better picture quality than those made by VHS-to-VHS editing.
- **S-VHS to S-VHS editing (S-VIDEO connection):** Original picture quality of S-VHS made can be duplicated with minimal picture degradation. This is the best editing method you can use on S-VHS VCRs.

You can use a camcorder as the playback VCR and your VCR as the recording VCR.

### S-VHS/VHS connection

Connect an audio cable between the camcorder's audio output connectors and your VCR's audio input connectors.

- When the JVC camcorder is equipped with the Master Edit Control, you can control the VCR from the camcorder. Connect the mini-plug cable (not supplied with this VCR) as illustrated on page 56.
- When using a camcorder with a monaural output, connect the audio output connector on the camcorder to the left audio input connector on this VCR.

#### NOTE:

If the camcorder does not have S-video output connector, use a video cable.

### 2 Load a cassette

Insert the cassette to be recorded on into this VCR (for recording).

### 3 Select input mode on this VCR

- L-1 or L-2 — when connecting the camcorder to the audio/video input connectors on the rear panel.
- F-1 — when connecting the camcorder to the audio/video input connectors on the front panel.

Press the **Number** key "**0 (AUX)**" or **CH +/-**.

### Select video input terminal

Access the "IN/OUT FUNCTION" screen (☞ pg. 49).

**When using S VIDEO terminal**, set "FRONT AUX F-1" (or "REAR AUX L-1 (or L-2)") if you use the connectors on the rear) to "S-VIDEO".

**When using VIDEO terminal**, set "FRONT AUX F-1" (or "REAR AUX L-1 (or L-2)") if you use the connectors on the rear) to "VIDEO".

### 5 Set "PICTURE CONTROL" to "EDIT" (for S-VHS/VHS connection)

Access the "VIDEO FUNCTION" screen (☞ pg. 48).

**If your camcorder is a JVC Master Edit Control-equipped type** — go to step **6**.

**If your camcorder is NOT a JVC Master Edit Control-equipped type** — go to step **■**.

### 6 Set "AV COMPU-LINK" to "OFF"

Access the "ADDITIONAL" screen (☞ pg. 48).

- The REMOTE PAUSE/AV COMPULINK connector works as the Remote Pause connector when "AV COMPU-LINK" is set to "OFF".

### Return to normal screen

Press **MENU**.

### 8 Start playback

Press **PLAY (▶)** on the camcorder.

#### NOTE:

If the camcorder is equipped with a superimpose/OSD disable feature then set it to "OFF" before starting playback.

### 9 Start recording

#### On the front panel:

Press **REC (●)**.

#### On the Remote:

Press **REC (●)** and **PLAY (▶)** at the same time.

- If you are using a Master Edit Control-equipped JVC camcorder, recording starts automatically on this VCR. (Refer to camcorder's instruction manual.)

#### NOTE:

Be sure to select "AUTO" for "PICTURE CONTROL" (or "NORM" when "V, CALIBRATION" is set to "OFF") after you finish dubbing the tapes (☞ pg. 49).



# Edit To Or From Another VCR/Other Devices

You can use your VCR as the playback or recording VCR.

- Refer also to the other VCR's instruction manual for connection and its operations.

*This VCR supports the copy protection technologies of DTLA (Digital Transmission Licensing Administrator). These technologies are admitted by DTLA (Digital Transmission Licensing Administrator).*

*It is impossible to dub copy-limited signals between the devices which supports copy protection technologies of DTLA . It is impossible to dub to other tapes the program which only one recording is permitted.*

*When connecting to other devices, only the operation of the devices which supports DTLA is guaranteed. The operation of non-DTLA-supported devices is not guaranteed.*

## Connection

Ex. When using this VCR as the playback VCR

This VCR (for playback)

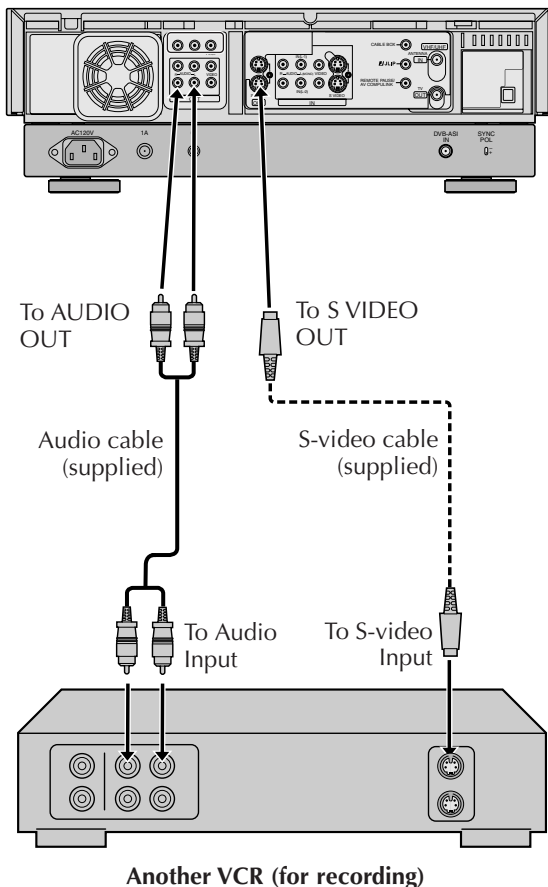

## S-VHS/VHS connection

Connect an audio cable between the playback VCR's audio output connectors and the recording VCR's audio input connectors.

- When using this VCR as the recording VCR, connect this VCR's audio input connectors to the audio output connectors on the other VCR. If the playback VCR is monaural, connect the audio output connector on the playback VCR to the left audio input connector on this VCR.

### NOTE:

*If another VCR does not have S-video input/output connectors, use a video cable.*

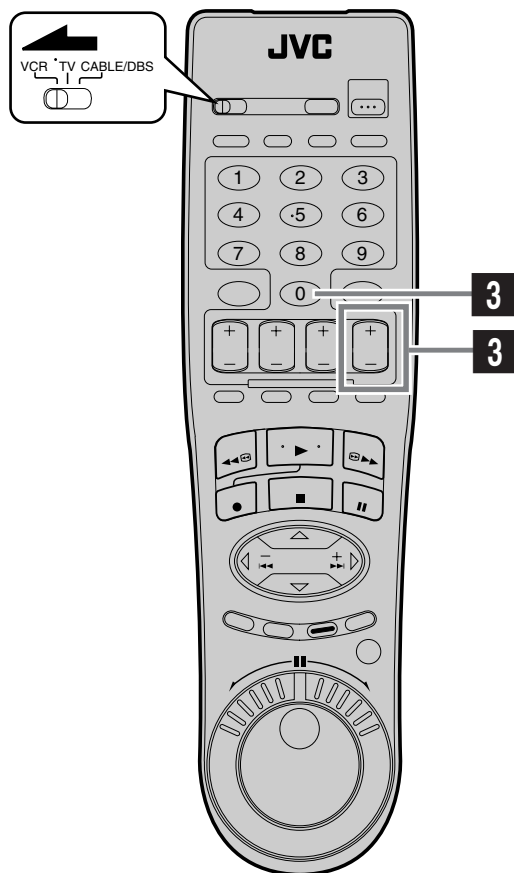

## 2 Load cassettes

Insert the playback cassette into the playback VCR and the cassette to be recorded on into the recording VCR.

## 3 Select input mode on recording VCR

Select the correct external input on the other VCR.

- On this VCR (when using this VCR as the recording VCR);
  - L-1 or L-2 — when connecting the other VCR to the audio/video input connectors or the rear panel.
  - F-1 — when connecting the other VCR to the audio/video input connectors on the front panel.

Press the **Number** key "0 (AUX)" or **CH +/-**.

### NOTES:

- When using this VCR as the recording VCR, set the video input terminal setting correctly (☞ pg. 57).
- When using this VCR as the playback VCR for editing, set "DIGITAL R3" to "OFF" (☞ pg. 49).

## Select edit mode

Set the edit mode to "ON" for the VCRs if such a mode is equipped.

- On this VCR, set "PICTURE CONTROL" to "EDIT" (☞ pg. 49).

## 5 Start playback

Press **PLAY** (▶) on the playback VCR.

### NOTE:

If the playback VCR is equipped with a superimpose/OSD disable feature then set it to "OFF" before starting playback (☞ pg. 52).

## 6 Start recording

Press **REC** (●) on the recording VCR.

### NOTE:

Be sure to select "AUTO" for "PICTURE CONTROL" (or "NORM" when "V, CALIBRATION" is set to "OFF") after you finish dubbing the tapes (☞ pg. 49).

# TV Brand Setting

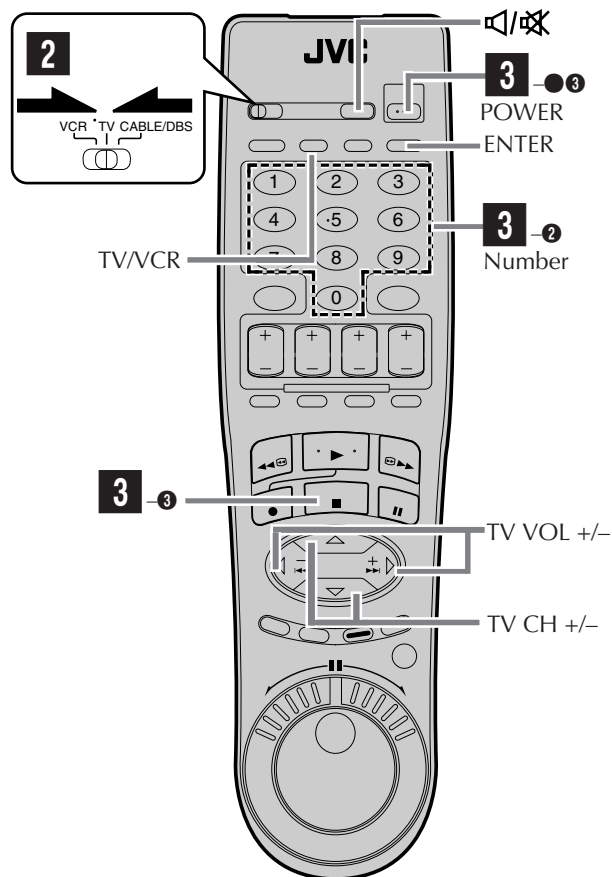

This Remote can control some functions of remote controllable TVs listed below. Without setting, you can control a JVC TV.

## 1 Turn on the TV

Turn on the TV using the Power button on the TV or its Remote.

## 2 Set remote operation mode

Set the **VCR/TV/CABLE/DBS** selector to "TV".

## 3 Set TV brand code

Follow the example shown below.

- 1 Press and hold **POWER**.
- 2 Press the **Number** keys to enter your TV's brand code by referring to the table below.
- 3 Press **STOP** (■), and release **POWER**.

- Once you have set the Remote to operate the TV, you do not have to set it until you replace the batteries from the Remote.
- JVC and PANASONIC have two codes. If the TV does not function with one code, try entering the other.

## Operate TV

First set the **VCR/TV/CABLE/DBS** selector to "TV", then press one of the following buttons: **POWER**, **TV/VCR**, **TV CH +/-**, **TV Muting** (TV Muting), **TV VOL +/-**, and **Number** keys.

- For some brands, you must press **ENTER** after having pressed the **Number** keys to enter a channel number.
- To operate the VCR, set the **VCR/TV/CABLE/DBS** selector back to "VCR".

## NOTES:

- Depending on the type of TV, some or all functions cannot be operated using this Remote.
- It's not possible to operate a TV not equipped with a remote sensor.

TV BRAND NAME	BRAND CODE
JVC	01, 03
HITACHI	10
MAGNAVOX	02
MITSUBISHI	03
PANASONIC	04, 11
RCA	05
SHARP	06
SONY	07
SAMSUNG	12
SANYO	13
SEARS	13
TOSHIBA	08
ZENITH	09

### (Ex.) To set Remote to RCA 05:

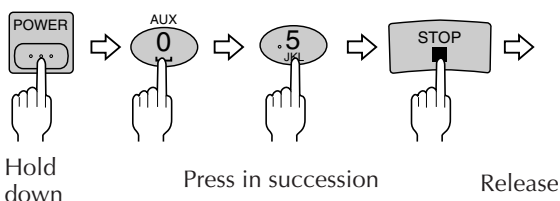

# Cable Box Brand Setting

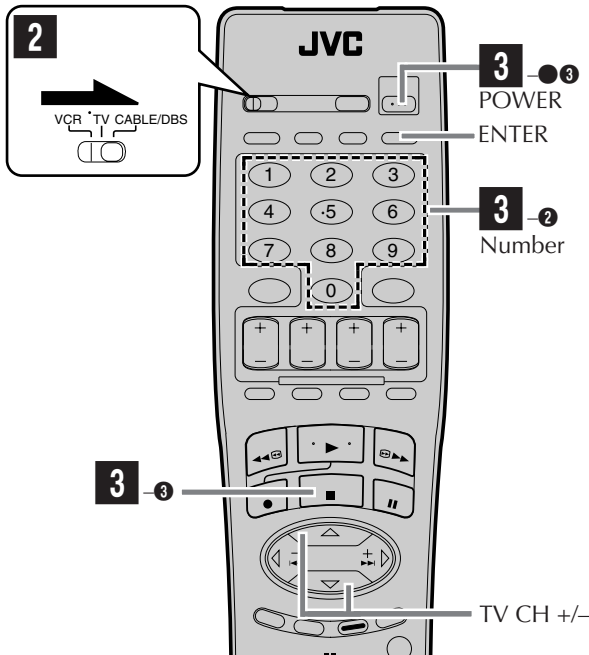

This Remote can control some functions of the cable boxes listed below. Some cable box brands have more than one code. If your cable box does not function with a specified code, try other codes.

**1 Turn on the cable box**  
Turn on the cable box using the Power button on the cable box or its Remote.

**2 Set remote operation mode**  
Set the **VCR/TV/CABLE/DBS** selector to "CABLE/DBS".

**3 Enter cable box brand code**  
Follow the example shown below.  
 1 Press and hold **POWER**.  
 2 Press the **Number** keys to enter your cable box's brand code by referring to the table below.  
 3 Press **STOP** (■), and release **POWER**.  
 • Once you have set the Remote to operate the cable box, you do not have to set it until you replace the batteries from the Remote.

**Operate cable box**  
First set the **VCR/TV/CABLE/DBS** selector to "CABLE/DBS", then press one of the following buttons: **POWER**, **TV CH +/-**, and **Number** keys.

- For some brands, you must press **ENTER** after having pressed the **Number** keys to enter a channel number.
- To change the cable box's channels, press **TV CH +/-** or the **Number** keys. (The **CH +/-** button can be used to change the VCR's channels only.)
- To operate the VCR, set the **VCR/TV/CABLE/DBS** selector back to "VCR".

## NOTES:

- Depending on the type of cable box, some or all functions cannot be operated using this Remote.
- It's not possible to operate a cable box not equipped with a remote sensor.
- It's not possible to set the Remote for both your cable box and a DBS receiver at the same time. You can only set the Remote control to operate one of these units at a time.

CABLE BOX BRAND NAME	BRAND CODE
ARCHER	01, 05, 17
CABLETENNA	01, 17
CABLEVIEW	15, 16, 17, 21, 25
CITIZEN	15, 16, 17, 21, 25
CURTIS	02
DIAMOND	01, 17
EASTERN	19
GC BRAND	15, 16, 17, 21, 25
GEMINI	15
GENERAL INSTRUMENTS	01, 04, 06, 11, 12, 15, 28
HAMLIN	10, 18, 19, 23
JASCO	15
JERROLD	01, 04, 06, 11, 12, 15, 28
NOVAVISION	02
OAK	07
PANASONIC	13, 14
PULSER	15, 16, 17, 21, 25
RCA	13, 14
REGAL	10, 18, 19, 23
REGENCY	19
REMBRANDT	01, 16, 17
SAMSUNG	05, 16, 24
SCIENTIFIC ATLANTA	02
SIGMA	07
SL MARX	05, 16, 17, 24, 25
SPRUCER	13, 14
STARGATE	05, 15, 16, 17, 21, 24, 25
TELEVIEW	05, 16, 24
TOCOM	01, 04, 16
UNIKA	01, 17
UNIVERSAL	16, 17, 25
VIDEOWAY	03, 09, 22
ZENITH	03, 09, 22

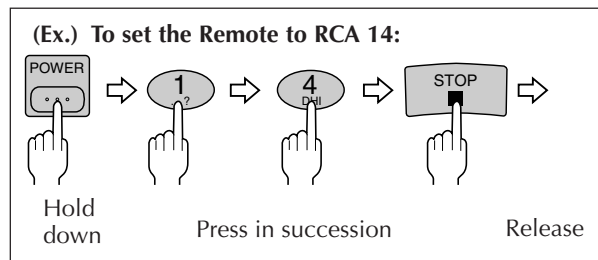

# DBS Receiver Brand Setting

This Remote can control some functions of the DBS (Direct Broadcast Satellite) receivers listed below.

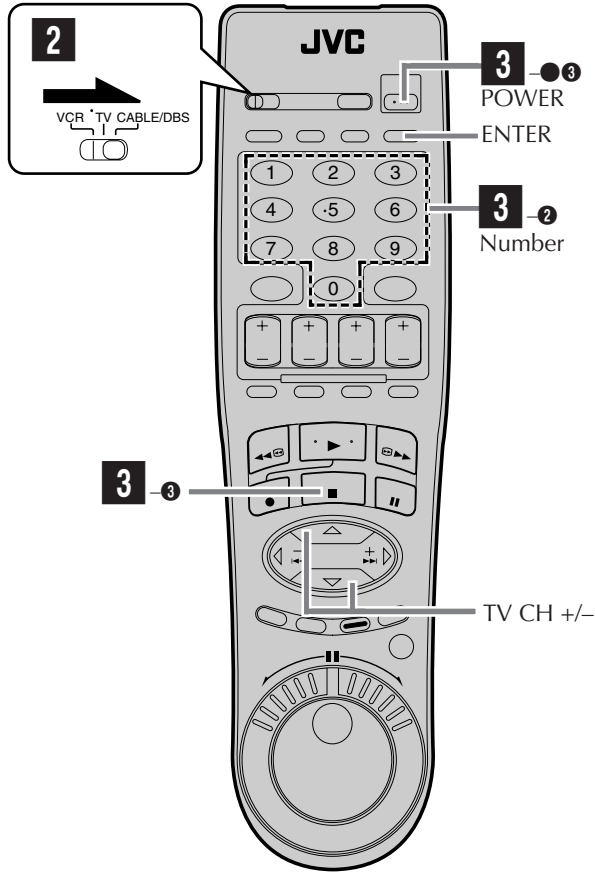

## 1 Turn on the DBS receiver

Turn on the DBS receiver using the Power button on the DBS receiver or its Remote.

## 2 Set remote operation mode

Set the **VCR/TV/CABLE/DBS** selector to "CABLE/DBS".

## 3 Enter DBS receiver brand code

Follow the example shown below.

- 1 Press and hold **POWER**.
  - 2 Press the **Number** keys to enter your DBS receiver's brand code by referring to the table below.
  - 3 Press **STOP** (■), and release **POWER**.
- Once you have set the Remote to operate the DBS receiver, you do not have to set it until you replace the batteries from the Remote.

## Operate DBS receiver

First set the **VCR/TV/CABLE/DBS** selector to "CABLE/DBS", then press one of the following buttons: **POWER**, **TV CH +/-**, and **Number** keys.

- For some brands, you must press **ENTER** after having pressed the **Number** keys to enter a channel number.
- To change the DBS receiver's channels, press **TV CH +/-** or the **Number** keys. (The **CH +/-** button can be used to change the VCR's channels only.)
- To operate the VCR, set the **VCR/TV/CABLE/DBS** selector back to "VCR".

## NOTES:

- Depending on the type of DBS receiver, some or all functions cannot be operated using this Remote.
- It's not possible to operate a DBS receiver not equipped with a remote sensor.
- It's not possible to set the Remote for both your DBS receiver and a cable box at the same time. You can only set the Remote to operate one of these units at a time.

DBS BRAND NAME	BRAND CODE
JVC (DISH Network)	51
ECHOSTAR (DISH Network)	51
PRIMESTAR	50
SONY (DSS)	41
RCA (DSS)	40

### (Ex.) To set the Remote to JVC 51:

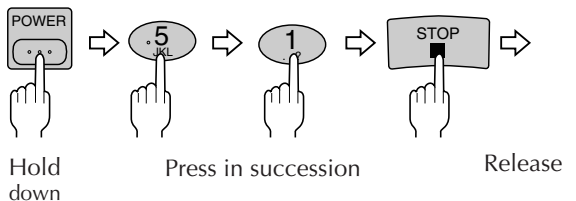

# Changing Remote Control Code

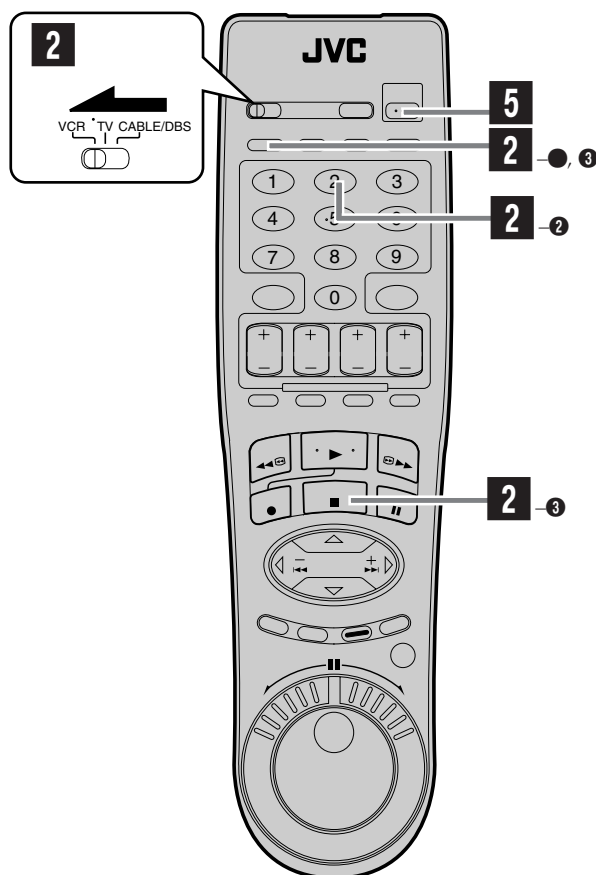

This Remote is capable of transmitting two control codes; one set to respond to A code control signals and another set to respond to B code control signals. This Remote control is preset to send A code signals because your VCR is initially set to respond to A code signals. You can easily modify your VCR and the Remote to respond to B code signals. When using two JVC VCRs, set two VCRs and their Remotes to different codes, so that you can operate these VCRs separately.

## Set remote operation mode

Set the **VCR/TV/CABLE/DBS** selector to "VCR".

## 2 Set remote control code for Remote

- Press and hold **A/B**.
- ② Press the **Number** key "2".
- ③ Press **STOP** (■), and release **A/B**.

## 3 Turn off VCR

Press **POWER** on the VCR.

## Check remote control code for VCR

Press **PLAY** (▶) on the VCR for more than 5 seconds.

- The code currently set appears on the front display panel.

## 5 Turn on VCR

Press **POWER** on the Remote.

- The code transmitted from the Remote blinks for a few seconds on the front display panel.
- After the code disappears on the front display panel, make sure that the VCR is turned on by pressing **POWER** on the Remote.
- To set the Remote and the VCR back to A code control signals, repeat the same procedure as shown above except pressing the **Number** key "1" in step 2.

## To control two VCRs with the same Remote

You can control two JVC VCRs by switching the remote control code for the Remote between A and B (☞ step 2), keeping two VCRs to different control codes.

- Press the **Number** key "1" for A code control signals and the **Number** key "2" for B code control signals. (To change only the remote control code for the Remote, DO NOT perform steps 3 to 5.)

### (Ex.) To set Remote to B code:

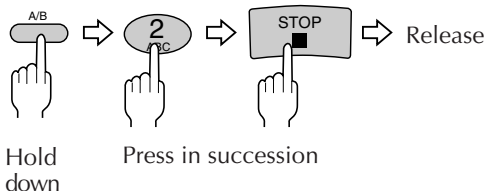

## NOTE:









When "POWER SAVE MODE" is set to "ON", you can not change the remote control code. Before changing the code, set "POWER SAVE MODE" to "OFF" (☞ pg. 52).

Before requesting service, use this chart and see if you can repair the trouble yourself. Small problems are often easily corrected, and this can save you the trouble of sending your VCR off for repair.

<b>POWER</b>		
<b>SYMPTOM</b>	<b>POSSIBLE CAUSE</b>	<b>CORRECTIVE ACTION</b>
1. The power will not come on.	<ul style="list-style-type: none"> <li>• The AC power cord is disconnected.</li> </ul>	Connect the AC power cord.
2. The clock works, but the VCR's power will not come on.	<ul style="list-style-type: none"> <li>• The VCR is in the timer recording standby mode with "AUTO TIMER" set to "OFF" (☞ pg. 52).</li> <li>• The child lock function is activated.</li> </ul>	<p>Press <b>TIMER</b> to disengage.</p> <p>Press and hold <b>POWER</b> on the Remote for more than seven seconds to release the child lock function (☞ pg. 72).</p>
3. The Remote will not function.	<ul style="list-style-type: none"> <li>• The batteries are discharged.</li> </ul>	Replace the dead batteries with new ones.
<b>TAPE TRANSPORT</b>		
<b>SYMPTOM</b>	<b>POSSIBLE CAUSE</b>	<b>CORRECTIVE ACTION</b>
1. The cassette gets stuck partway during loading, and is ejected.	<ul style="list-style-type: none"> <li>• The cassette was inserted incorrectly.</li> </ul>	Make sure the cassette's window is facing up, the rear label side is facing you and the arrow on the front of the cassette is pointing towards the VCR. Then insert the cassette.
<b>PLAYBACK</b>		
<b>SYMPTOM</b>	<b>POSSIBLE CAUSE</b>	<b>CORRECTIVE ACTION</b>
1. The tape is running but the picture will not appear.	<ul style="list-style-type: none"> <li>• The TV receiver is set to the wrong mode.</li> </ul>	Select the AV mode on the TV.
2. Breaks are noticeable in Hi-Fi sound track.	<ul style="list-style-type: none"> <li>• Automatic tracking is engaged.</li> </ul>	Disengage auto tracking and adjust the tracking manually (☞ pg. 23).
3. The playback picture is blurred or interrupted, even though TV broadcasts are clear.	<ul style="list-style-type: none"> <li>• The video heads may be dirty.</li> </ul>	The heads must be cleaned. Consult your JVC dealer.
4. The Hi-Fi sound cannot be heard.	<ul style="list-style-type: none"> <li>• Audio Monitor setting is incorrect.</li> </ul>	Set Audio Monitor to "HI-FI" (☞ pg. 23).
<b>RECORDING</b>		
<b>SYMPTOM</b>	<b>POSSIBLE CAUSE</b>	<b>CORRECTIVE ACTION</b>
1. Recording will not start.	<ul style="list-style-type: none"> <li>• There is no cassette loaded.</li> <li>• The loaded cassette has had its record safety tab removed.</li> </ul>	<p>Insert a cassette.</p> <p>Remove the cassette and cover the hole with adhesive tape, or load a cassette on which the record safety tab is intact.</p>
2. TV broadcasts will not be recorded properly.	<ul style="list-style-type: none"> <li>• The VCR has been set to "L-1", "L-2", "F-1" or "I-1 etc." input mode by mistake.</li> </ul>	Select the appropriate channel on the VCR.
3. Tape-to-tape editing will not work.	<ul style="list-style-type: none"> <li>• The components have been incorrectly connected, or correct video connector (S VIDEO, VIDEO or DV) is not selected.</li> <li>• The power to one or more of the units has not been turned on.</li> <li>• The recording VCR's input mode has been set incorrectly.</li> </ul>	<p>Connect the components correctly (☞ pg. 56 – 58) or check "REAR AUX L-1 (or L-2)" and "FRONT AUX F-1" setting (☞ pg. 51).</p> <p>Make sure the power to all units is on.</p> <p>Select the appropriate input mode on the recording VCR.</p>



## TIMER RECORDING

SYMPTOM	POSSIBLE CAUSE	CORRECTIVE ACTION
1. Timer recording will not work.	<ul style="list-style-type: none"> <li>● The clock and/or the timer have been set incorrectly.</li> <li>● The timer is not engaged.</li> <li>● The VCR has not been set up properly.</li> </ul>	<p>Set the clock and/or timer correctly.</p> <p>Press <b>TIMER</b> and check to make sure that  appears on the front display panel.</p> <p>Re-perform the set-up procedures. Make sure you have compensated for guide channel and VCR or cable box channel number mismatches (<a href="#">☞</a> pg. 36).</p>
2. Timer programing will not work.	<ul style="list-style-type: none"> <li>● Timer recording is in progress.</li> </ul>	<p>Timer programing cannot be performed when timer recording is in progress. Wait until it finishes.</p>
3.  and  on the front display panel will not stop blinking.	<ul style="list-style-type: none"> <li>● The timer is engaged but there is no cassette loaded.</li> </ul>	<p>Load a cassette with the record safety tab intact, or with the hole covered with adhesive tape.</p>
4. The cassette stops automatically, and  and  on the front display panel will not stop blinking.	<ul style="list-style-type: none"> <li>● The loaded cassette has had its record safety tab removed.</li> </ul>	<p>Remove the cassette and cover its hole with adhesive tape, or replace it with a cassette on which the safety tab is intact.</p>
5.  blinks for 10 seconds and the timer mode is disengaged.	<ul style="list-style-type: none"> <li>● <b>TIMER</b> has been pressed when there are no programs in memory, or the timer recording program has not been set correctly.</li> </ul>	<p>Check the programed data and set again if necessary, then press <b>TIMER</b> again.</p>
6. The cassette automatically stops, the power shuts off and  and  will not stop blinking.	<ul style="list-style-type: none"> <li>● The tape reaches its end during timer recording.</li> </ul>	<p>The program may not have been recorded in its entirety. Next time be sure you have enough time on the tape to record the entire broadcast.</p>
7. Cable channels are not automatically switched during timer recording.	<ul style="list-style-type: none"> <li>● The Controller is not properly connected to the VCR.</li> <li>● The output channel selected in the Cable Box Set screen is incorrect.</li> <li>● The cable box is turned off.</li> </ul>	<p>Connect the Controller correctly (<a href="#">☞</a> pg. 15).</p> <p>After confirming your cable box's output channel number, re-access the Cable Box Set screen and select the correct number (<a href="#">☞</a> pg. 16).</p> <p>Make sure the power is on before timer recording starts.</p>
8. Satellite channels are not automatically switched during timer recording.	<ul style="list-style-type: none"> <li>● The Controller is not properly connected to the VCR.</li> <li>● The output channel selected in the DBS Receiver Set screen is incorrect.</li> <li>● The VCR is not set correctly to control the DBS receiver.</li> <li>● The DBS receiver is turned off.</li> </ul>	<p>Connect the Controller correctly (<a href="#">☞</a> pg. 18).</p> <p>After confirming your DBS receiver's output channel number, re-access the DBS Receiver Set screen and select the correct number (<a href="#">☞</a> pg. 19).</p> <p>Set the correct DBS receiver brand code (<a href="#">☞</a> pg. 20).</p> <p>Make sure the power is on before timer recording starts.</p>
9. Timer recording begins as scheduled, but the channel is always incorrect.	<ul style="list-style-type: none"> <li>● Even though you do not use an external cable box or DBS receiver, "CABLE BOX SET UP" is set to "ON" or "DBS RECEIVER SET UP" is set to "ON".</li> </ul>	<p>Set "CABLE BOX SET UP" to "OFF" (<a href="#">☞</a> pg. 16) or "DBS RECEIVER SET UP" is set to "OFF" (<a href="#">☞</a> pg. 19).</p>
10. You moved, and now VCR Plus+ system does not work properly.	<ul style="list-style-type: none"> <li>● The receivable stations in the new area are received on different channels than those in the previous area.</li> </ul>	<p>Re-perform the Changing VCR Plus+ Setting procedure (<a href="#">☞</a> pg. 36).</p>
11. "PROGRAM FULL" is displayed on the screen.	<ul style="list-style-type: none"> <li>● All 24 programs of the VCR's timer memory are used.</li> </ul>	<p>Wait until a space in memory clears, or cancel unnecessary program information (<a href="#">☞</a> pg. 40).</p>

CONTINUED ON NEXT PAGE →



**OTHER PROBLEMS**

SYMPTOM	POSSIBLE CAUSE	CORRECTIVE ACTION
1. When scanning channels, some of them are skipped over.	<ul style="list-style-type: none"> <li>Those channels have been preset to be skipped.</li> </ul>	If you need the skipped channels, restore them (☞ pg. 14).
2. The channel cannot be changed.	<ul style="list-style-type: none"> <li>Recording is in progress.</li> </ul>	Press <b>PAUSE (II)</b> to pause the recording, change channels, then press <b>PLAY (▶)</b> to resume recording.
3. The Remote will not operate your TV or cable box or DBS receiver.	<ul style="list-style-type: none"> <li>The brand codes are set incorrectly.</li> </ul>	Reset the correct brand codes (☞ pg. 60, 61 or 62).
4. Even though Auto or Semiauto Clock Set has been performed, the clock is incorrect.	<ul style="list-style-type: none"> <li>The clock setting data received from the host channel is incorrect.</li> </ul>	Select a different host channel during Semiauto Clock Set (☞ pg. 11), or perform Manual Clock Set (☞ pg. 12).

**MOISTURE CONDENSATION**

Moisture in the air will condense on the VCR when you move it from a cold place to a warm place, or under extremely humid conditions—just as water droplets form on the surface of a glass filled with cold liquid. Moisture condensation on the head drum will cause damage to the tape. In conditions where condensation may occur, keep the VCR turned on for a few hours to evaporate the moisture before inserting a tape.

**ABOUT HEAD CLEANING**

Accumulation of dirt and other particles on the video heads may cause the playback picture to become blurred or interrupted. Be sure to contact your nearest JVC dealer if such troubles occur.

**ATTENTION**

This VCR contains microcomputers. External electronic noise or interference can cause microcomputer to malfunction. If the VCR does not operate correctly switch its power off and unplug the AC power cord from the AC supply. Wait for a while and then plug the power back in. Eject and check the condition of the cassette. If everything appears normal, you can operate the VCR as usual.

## Error Codes and Messages

Some error codes and messages may appear on the TV screen when operating the VCR. Refer to the chart below for the solution.

CODE	MESSAGE	DESCRIPTION
102	REC PROHIBITED	<ul style="list-style-type: none"> <li>● An attempt was made to make a PRO HD recording of a program for which only the analog information is copy protected.</li> <li>● While making a PRO HD recording of a program, a signal in which only the analog information is copy protected was input to this VCR.</li> </ul>
103	REC PROHIBITED	<ul style="list-style-type: none"> <li>● An attempt was made to dub a PRO HD recording of a digitally copy protected program.</li> <li>● While dubbing a PRO HD recording, digitally copy protected information was input to this VCR.</li> <li>● This VCR supports copy protection technologies such as DTLA, and cannot record programs that employ digital copy protection.</li> </ul>
104	CAN NOT DECODE VIDEO OR AUDIO USE SET TOP BOX OR HDTV TUNER	<ul style="list-style-type: none"> <li>● A signal that is not compatible with this VCR was input.</li> <li>● Switch to the analog input for recording. (It may be possible to play back the material if using a digital tuner*, etc.)</li> </ul>
200	CAN NOT DECODE VIDEO OR AUDIO USE SET TOP BOX OR HDTV TUNER	<ul style="list-style-type: none"> <li>● An attempt was made to play back a signal that is not supported by this VCR.</li> <li>● To play back the signal, use the digital tuner*, etc., that was used to record the signal.</li> </ul>
201	WAIT A MINUTE CALIBRATING. . .	<ul style="list-style-type: none"> <li>● Normal playback is being prevented by mosaic noise, etc.</li> <li>● Wait while the VCR calibrates itself so that it can output a normal image.</li> </ul>
202	COPY RESTRICTED PROG OUTPUT 480I VIDEO	<ul style="list-style-type: none"> <li>● When playing back a program that was copy protected in 1080i, 720p, or 480p mode, the VCR down-converts to 480i mode for output.</li> </ul>
203	COPY RESTRICTED PROG CAN NOT PLAY BACK	<ul style="list-style-type: none"> <li>● An attempt was made to play back a tape containing a copy protected program.</li> <li>● Even if you record a copy protected program, this VCR cannot play it back.</li> </ul>
205	CAN NOT PLAY BACK THIS TAPE	<ul style="list-style-type: none"> <li>● An attempt was made to play back a tape containing an invalid PRO HD recording.</li> </ul>
300	CAN NOT DECODE VIDEO OR AUDIO USE SET TOP BOX OR HDTV TUNER	<ul style="list-style-type: none"> <li>● A signal format that is not supported by this VCR was input.</li> <li>● Use a digital tuner*, etc.</li> </ul>
302	COPY RESTRICTED PROG OUTPUT 480I VIDEO	<ul style="list-style-type: none"> <li>● When playing back a program that was copy protected in 1080i, 720p, or 480p mode, the VCR down-converts to 480i mode for output.</li> </ul>

\* A digital tuner will be released in the future.

## Questions and answers

### PLAYBACK

- Q. What happens if the tape reaches its end during playback or search?**  
 A. The VCR automatically rewinds it to the beginning.
- Q. Can the VCR indefinitely remain in still mode?**  
 A. No. It stops automatically after 5 minutes to protect the heads.
- Q. During picture search, still picture playback and frame-by-frame playback, the picture is intermittent. What's the cause?**  
 A. Picture loss occurs when these types of playback are attempted with a tape recorded in LP mode. Pressing **PLAY (▶)** to return to normal playback will restore the picture.
- Q. When returning from variable-speed picture search to normal playback, the picture is disturbed. Should I be concerned about this?**  
 A. No, it is normal.
- Q. When playing back programs that have been timer-recorded consecutively (such one program from 8:00 to 9:00 and another one from 9:00 to 10:00), the picture and sound become momentarily distorted where the first program ends and the second program begins. Is this a malfunction?**  
 A. No. This is normal.
- Q. Sometimes, during index search, the VCR cannot find the program I want to see. Why not?**  
 A. There may be index codes too close together.
- Q. During playback, on-screen display sometimes jitters. Why does this happen?**  
 A. If the condition of the tape being played back is not good, jittering of the video (including on-screen display) may occur.

### RECORDING

- Q. When I pause and then resume a recording, the end of the recording before the pause is overlapped by the new recording. Why does this happen?**  
 A. This is normal. It reduces distortion at the pause and resume points.
- Q. Can the VCR indefinitely remain in the recording pause mode?**  
 A. No. The VCR automatically stops after 5 minutes to protect the heads. When paused during Instant Timer Recording (ITR), the VCR shuts off automatically after 5 minutes.
- Q. What happens if the tape reaches its end during recording?**  
 A. The VCR automatically rewinds it to the beginning.

### TIMER RECORDING

- Q. REC and ⊖ remain lit on the front display panel. Is there a problem?**  
 A. No. This is a normal condition for a timer recording in progress.
- Q. Can I program the timer while I'm watching a tape or a TV broadcast?**  
 A. Yes, but while you are setting the timer you will not see the tape's or broadcast program's picture as it is replaced by the on-screen menu. (The sound from the tape or broadcast program will be heard during the timer setting.)

## List of terms

This guide serves as a quick way to locate frequently used terms and on-screen display names.

### A

Accidental erasure prevention 30  
 Audio Monitor 23  
 Auto Daylight Saving Time 11  
 AUTO SP→ EP TIMER 52  
 AUTO TIMER 52  
 Automatic tracking 23  
 AV COMPU-LINK 53

### C

Cable box setting  
   Brand 16  
   Installing Controller 15  
   Output channel 16  
 Channel No. indication 28  
 Child Lock 72  
 Clock setting 10  
   Manual setting 12  
   Preparations 10  
   Semiauto setting 11  
 Clock time 22, 28  
 Connection 7  
   Connection to TV 7  
   S-VIDEO connection 8  
   Component Video Connection 8  
 Contents 6  
 Counter reset 22, 28

### D

DBS receiver setting  
   Brand 19  
   Installing Controller 18  
   Output channel 19  
 Digital 3-DNR 25  
 DIGITAL R3 49

### E

Editing  
   From camcorder 56  
   From another VCR/  
     other devices 58  
   Remote Pause function 53  
   To another VCR/  
     other devices 58  
 Express timer programming 38

### F

FRONT AUX F-1 51  
 FRONT DISPLAY 52  
 Front display panel 72

### G

GRAY BACK 52  
 Guide channel 36

### H

Host channel 9

### I

Index Search 24  
 Instant Review 25  
 Instant Timer Recording (ITR) 28

### J

JLIP ID Number Setting 55

### M

Manual tracking 23  
 Multi-Brand Remote  
   Controlling two JVC VCRs 63  
   Setting Cable Box brand 61  
   Setting DBS receiver brand 62  
   Setting TV brand 60

### N

Next Function Memory 24

### O

On-screen display 29, 73  
 OPTICAL OUT 50

### P

PBS channel 9  
 PICTURE CONTROL 49  
 Playback 21  
 Plug & Play 9  
 POWER SAVE MODE 52  
 PRE-RECORDED CC 53  
 PRO HD SYSTEM  
   Connection 43  
   Features 42  
   Password 46  
   Playback 47  
   Preparations 44  
   Recording 45

### R

REAR AUX L-1 51  
 REAR AUX L-2 51  
 Recording 26  
   S-VHS/VHS Recording 27  
 Recording Resume Function 30  
 Repeat playback 23

### S

Satellite Auto Recording 54  
 Skip Search 25  
 Special effect playback  
   Frame-by-Frame Playback 32  
   High-Speed Picture Search 31  
   Picture Search 31  
   Slow Motion Playback 33  
   Still Picture Playback 32  
   Variable-Speed Picture Search 31  
 Specifications 75  
 SUPERIMPOSE 52  
 Super VHS ET 31  
 S-VHS MODE 53

### T

Tape position indicator 22  
 Tape remaining time 22, 28  
 Tape speed 26, 27  
 Time counter 22, 28  
 Time zone selection 11  
 Timer recording  
   Canceling 40  
   Changing 40  
   Checking 40  
   Express 38  
   Guide channel setting 36  
   Overlap 41  
   VCR Plus+ 34  
 Tracking 23  
 Troubleshooting 64  
 Tuner setting  
   Adding channels 14  
   Auto Channel Set 13  
   Manual Channel Set 14  
   Skipping channels 14  
 TV OUTPUT 1 51  
 TV OUTPUT 2 51

### V

VCR Plus+ Setting 36

## Front panel

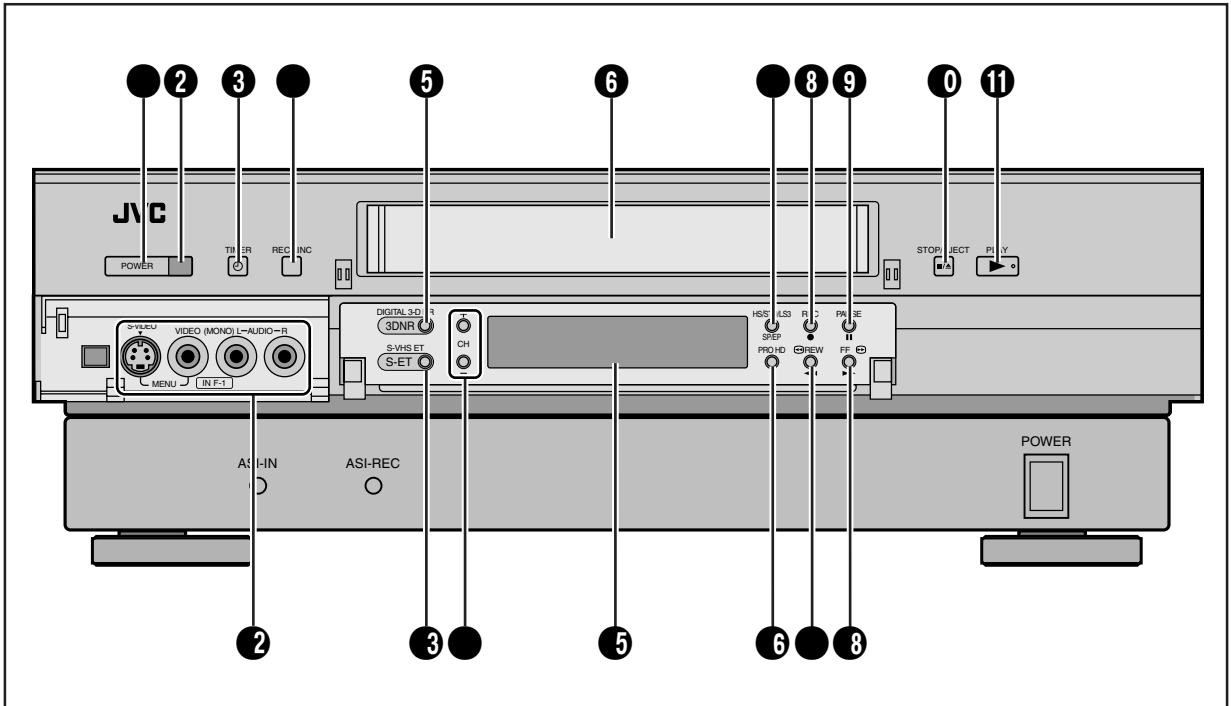

- POWER button : pg. 21, 27
- ② Remote sensor
- ③ TIMER button : pg. 35, 39, 40
- REC LINK button : pg. 54
- ⑤ DIGITAL 3-DNR button and lamp : pg. 25
- ⑥ Cassette loading slot
- HS/STD/LS3/SP/EP button : pg. 27
- ⑧ RECORD ( ● ) button : pg. 26, 27
- CH + and – buttons : pg. 23, 26, 27
- ⑤ Front display panel : pg. 72
- ⑥ PRO HD button : pg. 45
- REW ( ) button : pg. 21, 31
- ⑧ FF ( ) button : pg. 21, 31

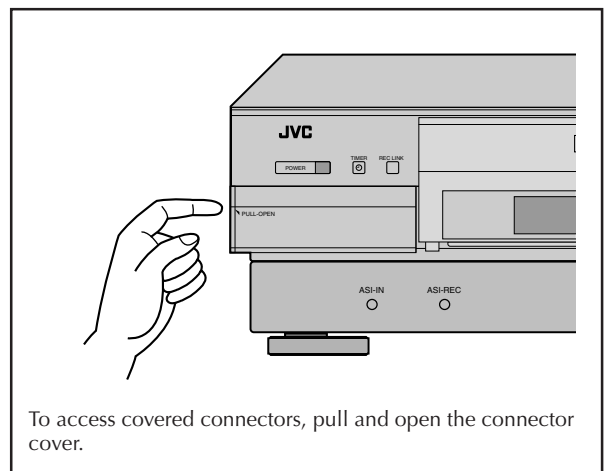

To access covered connectors, pull and open the connector cover.

## Rear panel

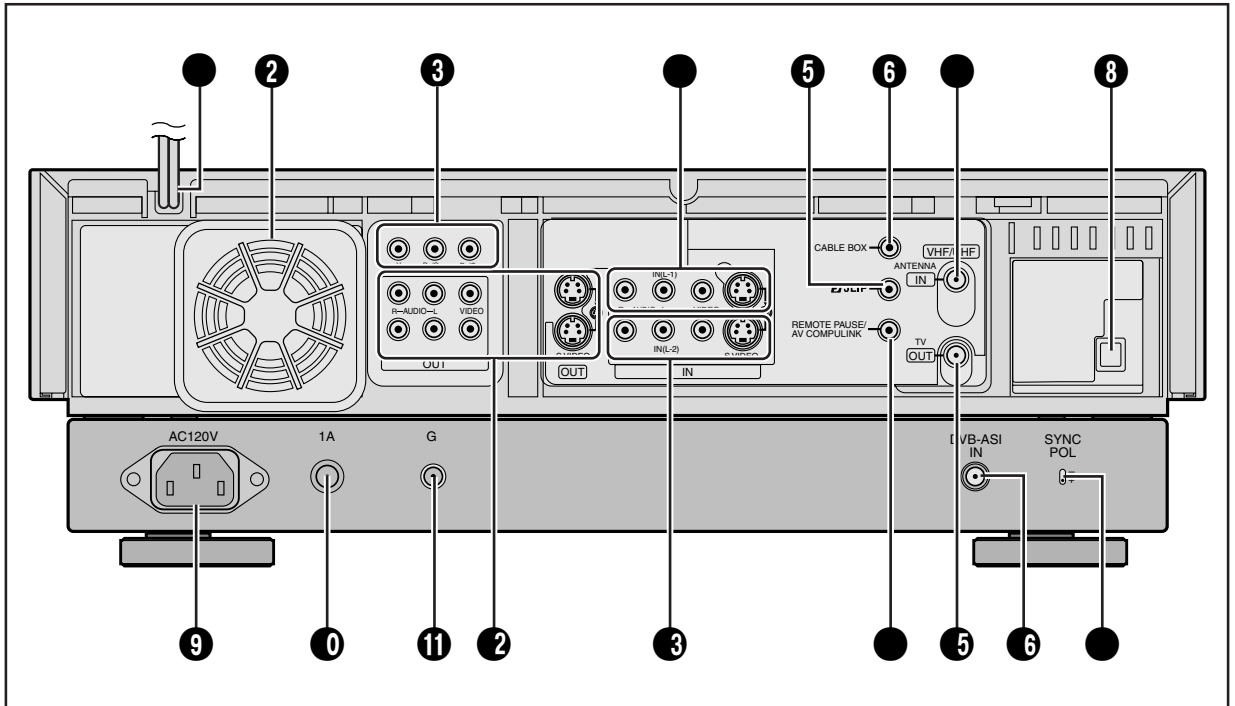

- 1 AC power cord : ☞ pg. 7
- 2 Cooling fan
  - This prevents the temperature from rising inside the VCR. Do not remove it.
  - Install the VCR so as not to block the area around the cooling fan.
- 3 Component video output connectors : ☞ pg. 8
- 4 S VIDEO/AUDIO/VIDEO IN connectors (L-1): ☞ pg. 58
- 5 J-LIP terminal : ☞ pg. 55
- 6 CABLE BOX Controller connector : ☞ pg. 15, 18
- 7 ANTENNA IN terminal : ☞ pg. 7
- 8 DIGITAL OUT (OPTICAL) connector : ☞ pg. 50
- 9 AC IN connector : ☞ pg. 43
- 10 Fuse socket
- 11 Ground terminal
- 2 S VIDEO/AUDIO/VIDEO OUT connectors : ☞ pg. 8, 58
- 3 S VIDEO/AUDIO/VIDEO IN connectors (L-2): ☞ pg. 58
- REMOTE PAUSE/AV COMPULINK terminal
  - REMOTE PAUSE terminal : ☞ pg. 56
  - AV COMPULINK terminal : ☞ pg. 53
- 5 TV OUT terminal : ☞ pg. 7
- 6 DVB-ASI IN terminal : ☞ pg. 43
- SYNC POL switch
  - This switch is usually set to a + (lower) side.

## Front display panel

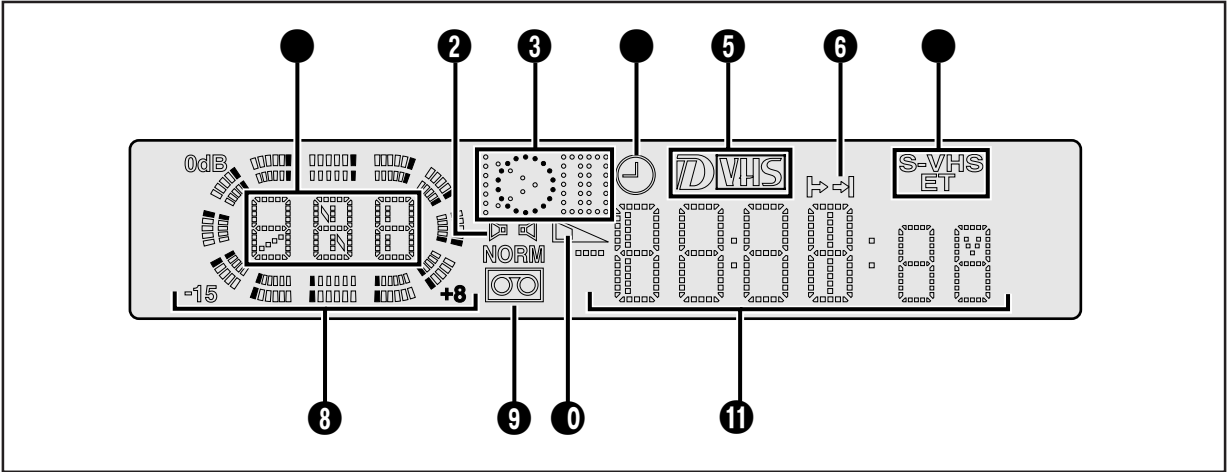

- Recording speed indicator : [pg. 26](#)  
Timer programming indicator ("Pro" appears when PROG. or PROG. CHECK button is pressed. "Err" appears when the guide channel error occurs.) : [pg. 40](#)
- Audio Monitor Indicators : [pg. 23](#)
- Symbolic Mode Indicators : [pg. 23](#)

PLAY: FF/REW VARIABLE SHUTTLE SEARCH:		STILL: SLOW:	
		RECORD:	
		RECORD PAUSE:	

- Timer mode indicator : [pg. 35, 39](#)
- D-VHS indicator : [pg. 45](#)
- Program Timer indicator : [pg. 40](#)
- S-VHS ET indicator : [pg. 29](#)

- Guide Track Indicators  
Remaining time (inside)/Tape position (out side) Indicators  
Audio level indicators (inside for right sound/ outside for left sound)  
*(You can select which of indicators above to display by setting "FRONT DISPLAY" ([pg. 52](#))).*
- Cassette mark
- Tape remaining time indicator : [pg. 22, 28](#)
- Channel and auxiliary input ("L-1", "L-2", "F-1" and "I-1 etc.")  
Counter reading : [pg. 22, 28](#)  
(If the counter exceeds -20 hours ("-20:00:00"), the display does not show the "-2" of "-20:00:00". In this case, confirm the counter on the TV screen.)  
Clock time : [pg. 22, 28](#)  
Child lock indicator : [See below](#)

## Child Lock

You can disable the VCR operations.

- You can only use the Remote for this operation.

**While the VCR is turned on, press and hold POWER on the Remote for more than 10 seconds.**

The VCR turns off, and the child lock indicator (CL) appears on the front display panel.

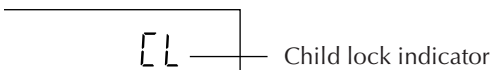

**To release the child lock,** press and hold **POWER** on the Remote until the VCR turns on.

- During timer recording, pressing **TIMER** also releases the child lock.

## NOTES:

- When the child lock function is in use, keep the Remote out of the children's reach.
- Timer recording programs will be performed even if the child lock function is activated.

- The child lock function is now activated and you cannot turn on the VCR by pressing **POWER** on the front panel.

## On-screen display

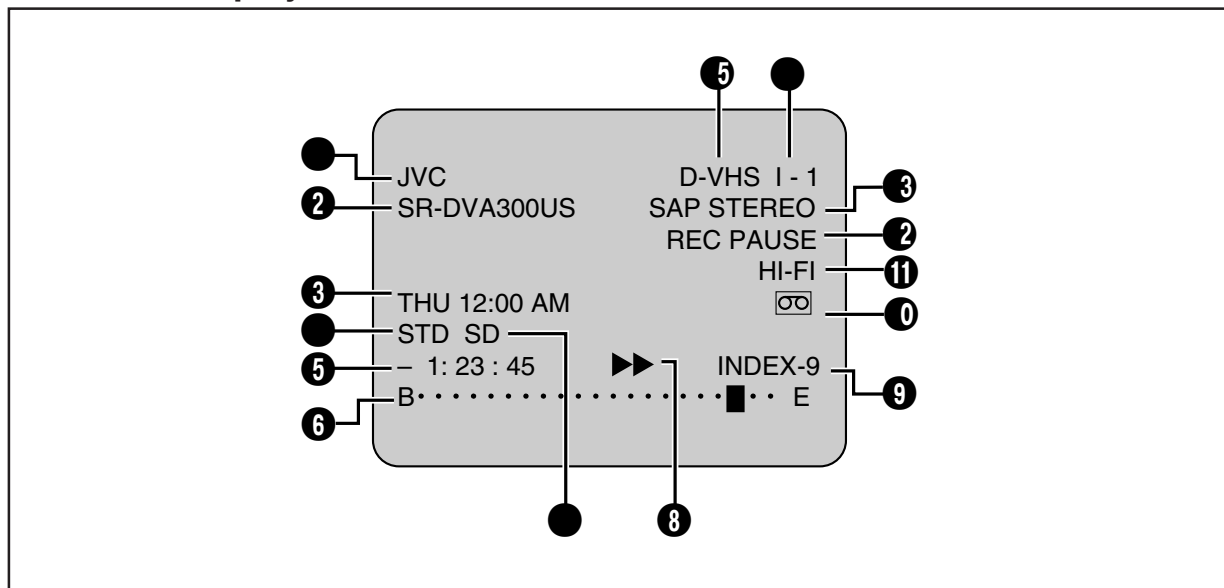

- 1 Brand name of the device connected to the DVB-ASI connector
- 2 Model name of the device connected to the DVB-ASI connector
- 3 Clock time
- 4 Tape speed indication
- 5 Time counter (When "COUNT" appears)  
: pg. 22, 28  
Tape remaining time (When "REMAIN" appears)  
: pg. 22, 28
- 6 Tape position indicator : pg. 22
- 7 Image format (HD/SD)
- 8 Tape direction
- 9 Index no. indication : pg. 24
- 10 Cassette indication
- 11 Audio monitor indications : pg. 23
- 12 VCR operation mode indication
- 13 STEREO program and SAP (Second Audio Program) indications : pg. 30
- 14 ID number of the device connected to the DVB-ASI connector
- 15 Type of device connected to the DVB-ASI connector

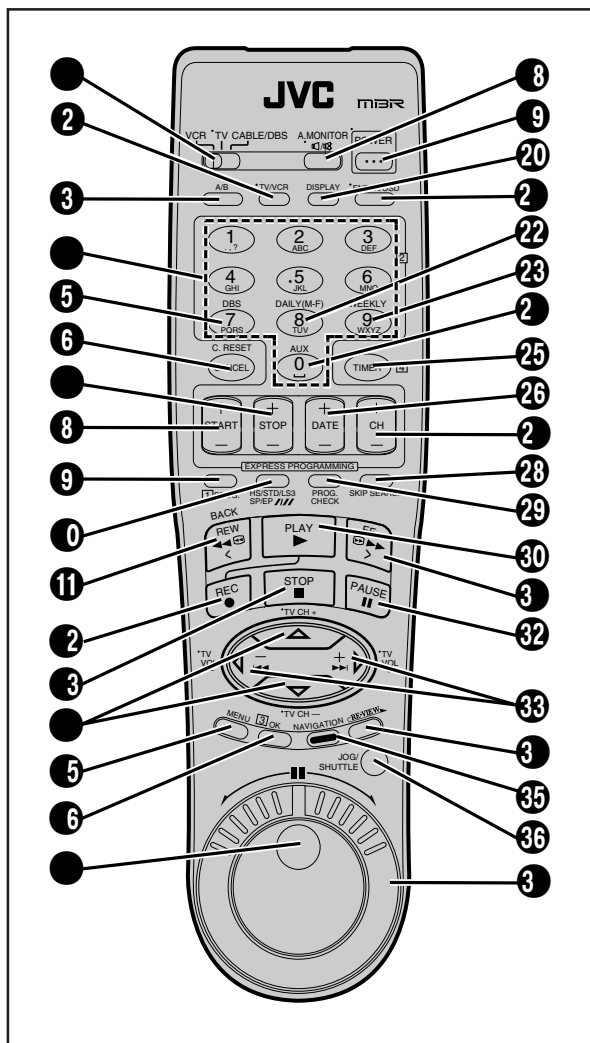

## Remote

**How to use the Remote**

Before use, insert two AA size batteries into the Remote with the polarity (+ and -) matched correctly as indicated on the battery compartment or on the lid.

The Remote can operate most of your VCR's functions, as well as basic functions of TV sets, cable boxes and DBS receivers.

- Point the Remote toward the remote sensor on the target component.
- The maximum operating distance of the remote control is about 8 m.

**NOTE:**

If the Remote does not work properly, remove its batteries, wait for a few seconds, replace the batteries and then try again.

- VCR/TV/CABLE/DBS selector : ☞ pg. 60 – 63
- 2 TV/VCR button : ☞ pg. 60
- 3 A/B button : ☞ pg. 63
- Number keys : ☞ pg. 26, 34  
Character input buttons : ☞ pg. 48
- 5 DBS button : ☞ pg. 39
- 6 CANCEL button : ☞ pg. 34, 40  
C. (Counter) RESET button : ☞ pg. 22, 28
- STOP +/- button : ☞ pg. 35, 38
- 8 START +/- button : ☞ pg. 38
- 9 PROG. (Program) button : ☞ pg. 34, 38
- 0 HS/STD/LS3/SP/EP (///) button : ☞ pg. 26, 27
- 11 REW ( ◀◀ ) button : ☞ pg. 21, 31  
BACK button : ☞ pg. 48
- 2 REC ( ● ) button : ☞ pg. 26, 27
- 3 STOP ( ■ ) button : ☞ pg. 21, 27
- Δ∇ buttons  
TV CH +/- buttons : ☞ pg. 60 – 62
- 5 MENU button
- 6 OK Button
- JOG dial : ☞ pg. 32
- 8 A. (Audio) MONITOR button : ☞ pg. 23  
⏸ (TV Muting) button : ☞ pg. 60
- 9 POWER button : ☞ pg. 21, 27
- 20 DISPLAY button : ☞ pg. 22, 28
- 2 ENTER button : ☞ pg. 60 – 62  
OSD button : ☞ pg. 29
- 22 DAILY (M-F) button : ☞ pg. 35, 39
- 23 WEEKLY button : ☞ pg. 35, 39
- 2 AUX button : ☞ pg. 57 – 59
- 25 TIMER button : ☞ pg. 35, 39, 40
- 26 DATE +/- button : ☞ pg. 38
- 2 CH +/- button : ☞ pg. 26, 38
- 28 SKIP SEARCH button : ☞ pg. 25
- 29 PROG. CHECK button : ☞ pg. 40
- 30 PLAY ( ▶ ) button : ☞ pg. 21, 23
- 3 FF ( ▶▶ ) button : ☞ pg. 21, 31
- 32 PAUSE ( || ) button : ☞ pg. 27, 32
- 33 ◀◀▶▶ (◁▷) button : ☞ pg. 24  
TV VOL +/- button : ☞ pg. 60
- 3 REVIEW button : ☞ pg. 25
- 35 No function
- 36 JOG/SHUTTLE button and lamp : ☞ pg. 32
- 3 SHUTTLE Ring : ☞ pg. 31

Buttons with a small dot on the left side of the name can also be used to operate your TV after setting the VCR/TV/CABLE/DBS selector to "TV". (☞ pg. 66).

**GENERAL**

Power requirement	: AC 120 V~, 60 Hz
Power consumption	
Power on	: 61 W
Power off	: 18 W
Temperature	
Operating	: 5°C to 40°C (41°F to 104°F)
Storage	: -20°C to 60°C (-4°F to 140°F)
Humidity	
Operating	: 35% to 80%
Operating position	: Horizontal only
Dimensions (W x H x D)	: 435 mm x 146 mm x 376 mm (17-3/16" x 5-3/4" x 14-13/16")
Weight	: 9.2 kg (20.3 lbs)
Maximum recording time	
PRO HD (HS)	: 210 min. with DF-420 video cassette
PRO HD (STD)	: 420 min. with DF-420 video cassette
PRO HD (LS3)	: 1260 min. with DF-420 video cassette
S-VHS/VHS (SP)	: 210 min. with ST-210 video cassette
S-VHS/VHS (EP)	: 630 min. with ST-210 video cassette

**VIDEO/AUDIO (PRO HD)**

Video format	: MPEG2 standard
Audio format	: Encode MPEG1 Layer2 Decode MPEG1 Layer2 Dolby Digital
Track composition	
Tape speed	: 33.4 mm/sec (HS mode) 16.67 mm/sec (STD mode) 5.55 mm/sec (LS3 mode)
Head azimuth	: ±30 deg
Drum rotation	: 1800 rpm
Tracking system	: CTL track system
Maximum recording data input rate	: 21 Mbps
Interface	: DVB-ASI

**VIDEO/AUDIO (S-VHS/VHS)**

Format	: S-VHS/VHS NTSC standard
Signal system	: NTSC-type color signal and EIA monochrome signal, 525 lines/60 fields
Recording/ Playback system	: DA-4 (Double Azimuth) head helical scan system
Signal-to-noise ratio	: 45 dB
Frequency range	
Normal audio	: 70 Hz to 10,000 Hz
Hi-Fi audio	: 20 Hz to 20,000 Hz

**TUNER**

Tuning system	: Frequency-synthesized tuner
Channel coverage	
VHF	: Channels 2-13
UHF	: Channels 14-69
CATV	: 113 Channels

**TIMER**

Clock reference	: Quartz
Program capacity	: 1-year programmable timer/ 24 programs
Memory backup time	: Approx. 60 min.

**CONNECTORS**

Input/Output	: RCA connectors (IN x 3, OUT x 2) S-video connectors (IN x 3, OUT x 2) Component video OUT (Y, P <sub>B</sub> /C <sub>B</sub> , P <sub>R</sub> /C <sub>R</sub> ) x 1 Digital OUT (optical) x 1 BNC connector (IN x 1)
--------------	---

**ACCESSORIES**

Provided accessories	: Infrared remote control unit, "AA" battery x 2, Audio cable, RF cable (F-type), S-video cable (4-pin), Controller AC power cord
----------------------	---

*Specifications shown are for SP mode unless specified otherwise.*

*E. & O.E. Design and specifications subject to change without notice.*

**HOW TO LOCATE YOUR JVC SERVICE CENTER****TOLL FREE: 1-800-537-5722****<http://www.jvc.com>****Dear customer,**

*In order to receive the most satisfaction from your purchase, please read the instruction booklet before operating the unit. In the event that repair is necessary, or for the address nearest your location within the Continental United States, please call 1-800-537-5722 for your nearest authorized servicer or visit our website at [www.JVC.com](http://www.JVC.com). Remember to retain your Bill of Sale for Warranty Service.*

— JVC

**JVC SERVICE & ENGINEERING  
COMPANY OF AMERICA  
DIVISION OF JVC AMERICAS CORP.**

*Sophisticated electronic products may require occasional service. Just as quality is a keyword in the engineering and production of the wide array of JVC products, service is the key to maintaining the high level performance for which JVC is world famous. The JVC service and engineering organization stands behind our products.*

NATIONAL HEADQUARTERS  
JVC SERVICE & ENGINEERING COMPANY OF AMERICA  
DIVISION OF JVC AMERICAS CORP.  
10 New Maple Avenue  
Pine Brook, NJ 07058-9641

**ACCESSORIES**

*To purchase accessories for your JVC product, you may contact your local JVC Dealer. From the 48 Continental United States call toll free: 1-800-882-2345 or on the web at [www.JVC.com](http://www.JVC.com)*

**Don't service the product yourself.****CAUTION**

*To prevent electrical shock, do not open the cabinet. There are no user serviceable parts inside. Please refer to qualified service personnel for repairs.*

**LIMITED WARRANTY**

**CONSUMER VIDEO 1-90**

JVC COMPANY OF AMERICA warrants this product and all parts thereof, except as set forth below ONLY TO THE ORIGINAL PURCHASER AT RETAIL to be FREE FROM DEFECTIVE MATERIALS AND WORKMANSHIP from the date of original retail purchase for the period as shown below. ("The Warranty Period")

PARTS	<b>1</b> YR	LABOR	<b>90</b> DAYS
-------	-------------	-------	----------------

THIS LIMITED WARRANTY IS VALID ONLY IN THE FIFTY (50) UNITED STATES, THE DISTRICT OF COLUMBIA AND IN COMMONWEALTH OF PUERTO RICO.

**WHAT WE WILL DO:**

If this product is found to be defective, JVC will repair or replace defective parts at no charge to the original owner. Such repair and replacement services shall be rendered by JVC during normal business hours at JVC authorized service centers. Parts used for replacement are warranted only for the remainder of the Warranty Period. All products and parts thereof may be brought to a JVC authorized service center on a carry-in basis except for Television sets having a screen size 25 inches and above which are covered on an in-home basis.

**WHAT YOU MUST DO FOR WARRANTY SERVICE:**

Return your product to a JVC authorized service center with a copy of your bill of sale. For your nearest JVC authorized service center, please call toll free: (800) 252-5722.

If service is not available locally, box the product carefully, preferably in the original carton, and ship, insured, with a copy of your bill of sale plus a letter of explanation of the problem to the nearest JVC Factory Service Center, the name and location of which will be given to you by the toll-free number.

If you have any questions concerning your JVC Product, please contact our Customer Relations Department.

**WHAT IS NOT COVERED:**

This limited warranty provided by JVC does not cover:

1. Products which have been subject to abuse, accident, alteration, modification, tampering, negligence, misuse, faulty installation, lack of reasonable care, or if repaired or serviced by anyone other than a service facility authorized by JVC to render such service, or if affixed to any attachment not provided with the products, or if the model or serial number has been altered, tampered with, defaced or removed;
2. Initial installation and installation and removal for repair;
3. Operational adjustments covered in the Owner's Manual, normal maintenance, video and audio head cleaning;
4. Damage that occurs in shipment, due to act of God, and cosmetic damage;
5. Signal reception problems and failures due to line power surge;
6. Video Pick-up Tubes/CCD Image Sensor, Cartridge, Stylus (Needle) are covered for 90 days from the date of purchase;
7. Accessories;
8. Batteries (except that Rechargeable Batteries are covered for 90 days from the date of purchase); from the date of purchase);

There are no other express warranties except as listed above.

THE DURATION OF ANY IMPLIED WARRANTIES INCLUDING THE IMPLIED WARRANTY OF MERCHANTABILITY, IS LIMITED TO THE DURATION OF THE EXPRESS WARRANTY HEREIN.

JVC SHALL NOT BE LIABLE FOR THE LOSS OF USE OF THE PRODUCT, INCONVENIENCE, LOSS OR ANY OTHER DAMAGES, WHETHER DIRECT, INCIDENTAL OR CONSEQUENTIAL (INCLUDING, WITHOUT LIMITATION, DAMAGE TO TAPES, RECORDS OR DISCS) RESULTING FROM THE USE OF THIS PRODUCT, OR ARISING OUT OF ANY BREACH OF THIS WARRANTY. ALL EXPRESS AND IMPLIED WARRANTIES, INCLUDING THE WARRANTIES OF MERCHANTABILITY AND FITNESS FOR PARTICULAR PURPOSE, ARE LIMITED TO THE WARRANTY PERIOD SET FORTH ABOVE.

Some states do not allow the exclusion of incidental or consequential damages or limitations on how long an implied warranty lasts, so these limitations or exclusions may not apply to you. This warranty gives you specific legal rights and you may also have other rights which vary from state to state.

JVC COMPANY OF AMERICA  
DIVISION OF JVC AMERICAS CORP.

1700 Valley Road  
Wayne, New Jersey 07470

REFURBISHED PRODUCTS CARRY A SEPARATE WARRANTY, THIS WARRANTY DOES NOT APPLY. FOR DETAILS OF REFURBISHED PRODUCT WARRANTY, PLEASE REFER TO THE REFURBISHED PRODUCT WARRANTY INFORMATION PACKAGED WITH EACH REFURBISHED PRODUCT.

**For customer use:**

Enter below the Model No. and Serial No. which is located either on the rear, bottom or side of the cabinet. Retain this information for future reference.

Model No.: \_\_\_\_\_

Serial No.: \_\_\_\_\_

Purchase date: \_\_\_\_\_

Name of dealer: \_\_\_\_\_





# ATTENTION

JVC EXPRESSLY DISCLAIMS ALL WARRANTIES, EXPRESS OR IMPLIED, AND SHALL NOT BE LIABLE FOR ANY AND ALL DAMAGES, CLAIMS OR LIABILITIES, DIRECT OR INDIRECT, ARISING FROM OR RELATING TO THE USE OF THIS PRODUCT WITH ANY OTHER PRODUCT, DEVICE, COMPONENT, PART OR MATERIAL THAT IS NON-CONFORMING OR NON-COMPATIBLE WITH THIS PRODUCT.

SR-VDA300U

# JVC

VICTOR COMPANY OF JAPAN, LIMITED